



SCHLEIFENBAUER

LIVING FOR THE POWER TO DELIVER

V2.62 Schleifenbauer PDU

User manual



Table of Content

Overview	5
What's new	5
Introduction	6
Power distribution meets intelligence	6
Interfaces	6
Accessories	6
Colored housing	7
Measurements	7
Part I - Installation of hardware	8
Safety warnings	8
Expert personnel	8
Technical installation requirements	8
Visual inspection	8
Testing	9
Cleaning	9
Contents of the package	9
Additionally needed tools for installation	9
Mounting the PDU in cabinets	9
How to mount a PDU horizontally (19 inch)?	9
How to mount a PDU vertically (= 0U)?	10
How to install on a flat surface? Table top mount	10
How to prevent hot spots in a cabinet? Sunken installation	10
How to mount a PDU without tools?	10
How to achieve maximum mounting flexibility? Mounting with profile clamps	10
Cabling the PDU: ethernet, databus and sensors	11
How to connect the PDU to LAN?	11
How to connect a databus?	11
How to connect sensors to a PDU?	11
How to connect a NO/NC contact on Classic PDU and ethernet PDU?	12
How to connect NO/NC contact on a G3 PDU?	12
Part II - User manual	13
How to maintain a PDU?	13
How to be sure the status of switchable outlets will not change during firmware upgrade or restarting of the controller?	13
Life-Supporting Policy	13
Part IIA - Locally monitoring: device display	14
How to change settings locally via PDU display?	14
How to stop a blinking display? Local alert reset	15
Why do alerts occur?	15
How to check the load balance, the temperature / humidity or the status of the NO/NC contact?	15
How to get back to the first page?	16
How to check an outlet status locally?	16
How to check input and/or outlet measurements?	16

How to read measurements of optional sensors and what options are possible?	17
Option 1: load page	17
Option 2: sensor pages	17
How to read Branch Residual Current measurements?	18
Data center practice: Residual Current Monitoring in relation to Residual Current Devices	18
Where to measure residual current?	18
How to find the PDUs unit address, tag, name or location?	18
How to view PDU connection information?	19
How can I check in which mode and with what protocol the PDU is running?	19
How to check the installed firmware version?	20
How to check for traceability information ?	20
Part IIB - Remote operating and monitoring: Web interface	21
Introduction	21
Login	21
How to select English or German language?	21
How to enlarge a pane in L sized screens?	21
User interface	22
How to change and save settings in the web interface?	22
Dashboard – tab	23
System status	23
Load	25
Interfaces	26
Sensors – tab	27
Inputs – tab	28
Outlets – tab	29
System – tab	31
Identification	32
Configuration	33
Reset	33
Settings	34
Locate	36
Interfaces – tab	37
Part III - Administrator manual	38
Specific manuals	38
How to change SNMPv3 settings?	39
How to use the ‘device list’ section in the web interface?	40
How to add new devices on an existing ring? How to solve duplicate devices?	40
How to configure login profiles, usernames and passwords?	41
How to change factory passwords?	42
How to change the Ethernet link settings?	42
Network configurations	43
DHCP and default address	43
How to change the hostname?	43
How to configure the IP settings manually?	43
How to setup IPv6?	44

IPv6 Autoconfigure (SLAAC)	44
Static IP	44
How to configure IPv6?	45
How to set up IPv6 address filtering?	46
Configure SSL certificates	47
Key Generation	47
TLS Cipher Suites Supported:	47
Note on self-signed certificates	48
Certificate Generation	48
How to send SNMP Traps with IPv6?	49
How to stop alert signaling? (auto reset alert)	50
Firmware downgrade / upgrade	50
How to upgrade the firmware? Using SPST	50
How to upgrade the firmware? Using USB	51
Schleifenbauer databus: what is it?	52
How to prevent data losses because of cable cuts? Ring redundancy	53
How to create a databus using Schleifenbauer Gateway?	54
How to connect the databus to LAN without a Gateway? Using a PDU!	55
PART IV - Problem Solving	56
How to perform a “Software reset”? And why?	56
Remotely	56
Locally	56
How to perform a “Factory reset”?	56
How to reset peak current? And other dips or peaks	57
Recycling	58
PRODUCT SPECIFICATIONS	58
SERVICE AND SUPPORT	58

OVERVIEW

The Schleifenbauer Power Distribution Unit (PDU) is fully configurable and allows customers to connect a variety of power appliances. Furthermore, the PDU allows remote management through a number of protocols which allow users to monitor metered sockets and receive alarms on custom thresholds. This manual is split in four sections:

Part I	Installation manual	Prepare PDU for use: <ul style="list-style-type: none">● safety issues● mounting the PDU● cabling the PDU
Part II	User manual	Operator and user part: <ul style="list-style-type: none">● operating/read out via the PDU-display● operating/read out via the web interface● problem solving
Part III	Administrator manual	Admin part: <ul style="list-style-type: none">● configure via the web interface● set up via the web interface● problem solving
Part IV	Problem Solving	In this chapter you can find the frequently asked questions (FAQs).

Users can focus on the section that fulfills their need when installing, operating and/or managing the PDU. The “Problem Solving” section is meant to guide users in resolving problems. It is not necessary to read the complete manual.

WHAT'S NEW

- Added choice of DHCP hostname: serial number or sysname.
- Added locate function that blinks PDU display at request.
- Added devicetype readout (sdbDevIdDeviceType).

INTRODUCTION

POWER DISTRIBUTION MEETS INTELLIGENCE

The Schleifenbauer Intelligent Power Distribution Unit (PDU) is designed to distribute power for many years and without problems. The PDU is equipped with a specially developed Schleifenbauer databus which makes it possible to read and manage many PDUs with a single IP address. An ethernet port is added to each PDU so that next to the advantages of a databus, a whole range of new options has become available. Schleifenbauer PDUs merges the interests between IT and infrastructures, making it a real bridge builder. Monitoring capabilities will be described in detail within this manual in upcoming sections.

The PDU may contain:

- metered outlets
- switched outlets
- metered and switched outlets
- passive outlets

Customers can configure the number and types of outlets of their PDU to their requirements by using Schleifenbauers customization tool when ordering.

INTERFACES

There are several interfaces integrated in the PDU:

- (embedded) web interface
- Modbus/TCP
- SNMP (Simple Network Management Protocol)
- (SP)API (Schleifenbauer Products Application Programming Interface)

In the Admin section of this manual you will find information about the “Interfaces” that describe the technology to communicate via your LAN (Local Area Network) with the Schleifenbauer databus.

ACCESSORIES

The following accessories can be purchased from Schleifenbauer:

- C14/C20 plugs if C13/C19 outputs are used (please check [Outputs on www.schleifenbauer.eu](http://www.schleifenbauer.eu))
- Different types of attachment brackets
 - 19” rack mounting brackets
 - Tabletop mounting brackets
 - Mounting plates for sunken installation
 - Profile clamps
 - Toolless Mounts
- Customer Specific solutions related tools

Please check the [Installation Section](#) for more details regarding mounting brackets.

Please check www.schleifenbauer.eu for further details regarding the accessories.

COLORED HOUSING

The default enclosure color of the Schleifenbauer PDUs is black. It is also possible to anodize the enclosure in five other colors.



- 01. black
- 02. green
- 03. orange
- 04. blue
- 05. red
- 06. yellow

Not shown but also available is enclosure color "natural"

Note: actual colors may vary!

MEASUREMENTS

The PDU is capable of measuring a number of quantities, either at the input, output or an optional sensor. Measurements quantities are shown below:

Measurement	Unit	Remark
Energy	(kWh)	total & subtotal
Voltage	(V)	with voltage dip registration
Current	(A)	with peak value registration and drop detection.
Power factor	(%)	
Apparent power	(VA)	
Real power	(W)	
Temperature	(°C)	optional sensor
Relative humidity	(%)	optional sensor
NO/NC contact	0-2	devices equipped with a USB-port can operate two NO/NC contacts (see chapter " How to connect a NO/NC contact ")

PART I - INSTALLATION OF HARDWARE

Please use the information in this chapter to inspect, install and connect the Schleifenbauer Intelligent PDU and all optional mentioned accessories.



The PDU must be installed in a restricted access location

Socket-outlet must be installed near the equipment

Socket-outlet must be easily accessible

Installation by expert personnel only

After installation: default passwords / RC4 keys **MUST** be changed (see: [Part III - Administrator manual](#))

SAFETY WARNINGS

This manual contains important safety instructions that should be followed during installation and operation of the PDU. Please read this manual carefully since there may be serious or fatal personal injury and damage to the equipment if the safety instructions, warnings and directions are not complied with. Please save this document for future use.

EXPERT PERSONNEL

Installation, maintenance and inspection of the Schleifenbauer Intelligent PDU must be carried out by adequately trained persons according to NEN EN 50110-1, with full observance of the specifications of NEN EN 50110-1 and NEN 3140.

TECHNICAL INSTALLATION REQUIREMENTS

Before installing and using the system, check whether the characteristics of the electrical system to which connection is to be made correspond to the product specifications.

- The Schleifenbauer Intelligent PDU has been designed for connection to electrical systems that comply with IEC 60364 or in the Netherlands, NEN 1010.
- The voltage, maximum permitted current and the number of phases must be correct. This information is displayed on the front side of the PDU.
- The maximum permitted power must be taken into account with regard to the maximum length and the diameter of the connecting lead.
- The values and characteristics of the in-series protective devices must match the PDU and the protective elements included in it.
- The environmental factors must correspond to the product specifications.

VISUAL INSPECTION

After opening the cardboard box and removing the packaging material, the PDU should be checked visually. The PDU should not be put into operation if damage is detected in a way that safe and proper operation cannot be guaranteed. In such cases, please contact Schleifenbauer Products BV. Note that, in the case of PDUs that are equipped with an overvoltage protection, the overvoltage protection and the respective overcurrent protection (if applicable) must be inspected on a regular basis.

TESTING

Each Schleifenbauer PDU is individually tested according to the NEN 3140 standard. Test reports are available on request.



For measurement of insulation resistance, the measuring voltage used must be lower than or equal to the voltage according to the product specification.

CLEANING

The PDU may only be cleaned by wiping off the outside with a clean dry cloth.

CONTENTS OF THE PACKAGE

The Schleifenbauer Intelligent PDUs are shipped in a cardboard box. Where applicable, dispose the packaging material in a responsible manner, in accordance with local regulations. All of the materials used for packaging can be recycled. Immediately after receipt, check whether you have received your order in a complete and undamaged state.

The following items are delivered for each PDU:

- fixing materials: these can be attached to the PDU (19" or table-mounting brackets), or are delivered separately if they have been ordered separately;
- the installation manual (one per shipment);

Please note that the PDU User Manual can also be found online at <http://schleifenbauer.eu>

ADDITIONALLY NEEDED TOOLS FOR INSTALLATION

The following tools are needed to install the PDUs:

- cage-nuts with bolts and washers
- suitable screwdriver.

MOUNTING THE PDU IN CABINETS

How to mount a PDU horizontally (19 inch)?

Each 19" rack bracket of a PDU has holes for horizontal mounting in 19" racks. The holes are positioned so that an appropriate fixing hole is always available for a PDU with a profile height of 1.5 U. Using one or two of the four holes allows mounting without wasting space.



How to mount a PDU vertically (= 0U)?

In case of a PDU for vertical mounting, the connection lead is fed through a hole in the upper, bottom or front face.

How to install on a flat surface? Table top mount

Gives the profile possibility to be mounted to a flat surface (tabletop). This arrangement is used for:

- vertical mounting to the bracing beams in the 19" cabinet
- fixing to a mounting plate
- mounting between the 19" uprights: the profile attaches to the front of the uprights

The holes on the brackets are located as far as possible to the outside so that it can also fit with enough space to tighten the bolts if a swivel gland has been placed on the short side.



How to prevent hot spots in a cabinet? Sunken installation

When power leads might block the flow of hot exhaust air, especially in case of a 600mm wide cabinet, it is necessary to create additional space for airflow. This can be done by using the "sunken installation brackets". Because of the shape of the bracket, it is possible to 'partially sink' the profile into the cabinet and save space. These mounting plates can be used for many different cabinets.

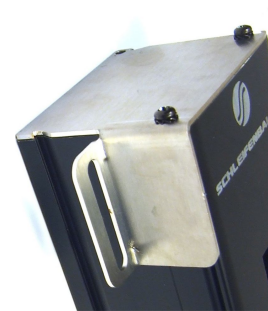

How to mount a PDU without tools?

Toolless mounting is created by making attachment points on the rear of the PDU housing. There is a wide range of cabinet brackets available, all in which you can hang the PDU without using tools.

Toolless Mounting can be done as single PDU or double PDUs (see image).

Mounting brackets can be custom made by Schleifenbauer.

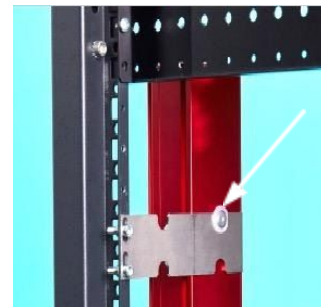

How to achieve maximum mounting flexibility? Mounting with profile clamps

The clamps, made of spring steel, can be installed in the position of your choice. The clamp fits around the PDU profile and is secured with a fastening screw. Our advice is to use one clamp for every 50 cm of profile length.



CABLING THE PDU: ETHERNET, DATABUS AND SENSORS

How to connect the PDU to LAN?

10/100 Mbps LAN Ethernet port

Connecting the PDU to a Local Area Network (LAN) provides communication through an Ethernet network. Multiple PDUs can share the same ethernet connection by using the databus (Bridge or Hybrid mode). More about the different operating modes in the section “Schleifenbauer databus, what is it?” The RJ45 connector for the network cable must be plugged into the silver Ethernet port:



Connect the RJ45 Ethernet cable to the Ethernet port on the PDU and to the Ethernet connector on the LAN device; when connected, the orange LED – marked “Ink” - will blink

How to connect a databus?

There are three black communication ports. One is marked as sensorport, the other two as databus ports (in and out). The left databus port is the “incoming” databus port. The right databus port is “outgoing”. This is a MUST HAVE for devices in bridge mode. For devices in hybrid mode it is a NICE TO HAVE. The serial databus in the Schleifenbauer PDU uses CAT5 patch cables.

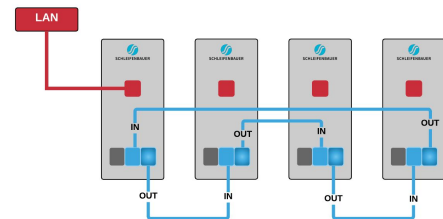

Data will be send and received by both ports but to close the databus ring, it is recommended to follow the connection diagram to ensure maximum performance.

How to connect sensors to a PDU?

The PDU has a RJ12 connector sensor port which can connect one of the following:

- a digital temperature sensor
- a combined sensor for temperature/humidity
- one or multiple dry switch contacts



Plug and play

Sensors are automatically recognized by the PDU and will update the display and menu accordingly.



Use Schleifenbauer sensors only

How to connect a NO/NC contact on Classic PDU and ethernet PDU?

The sensor port makes use of the RJ12 6P6C standard (= 6 position, 6 conductor). To connect a NO/NC contact on the PDU sensor port, you have to make use of pin 1 and pin 6 ; as shown in the image below.

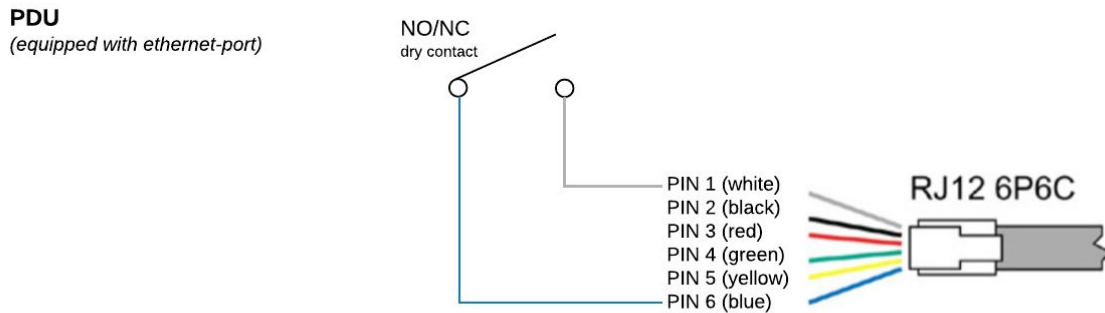

Note that on a PDU only 1 NO/NC contact can be connected.



Status of the contact will be displayed. The state cannot be changed locally.

Classic PDUs (= without ethernet port) do not support a NO/NC contact

How to connect NO/NC contact on a G3 PDU?

3rd generation PDUs and DPMs are equipped with a USB-port and are able to operate two NO/NC dry switch contacts:

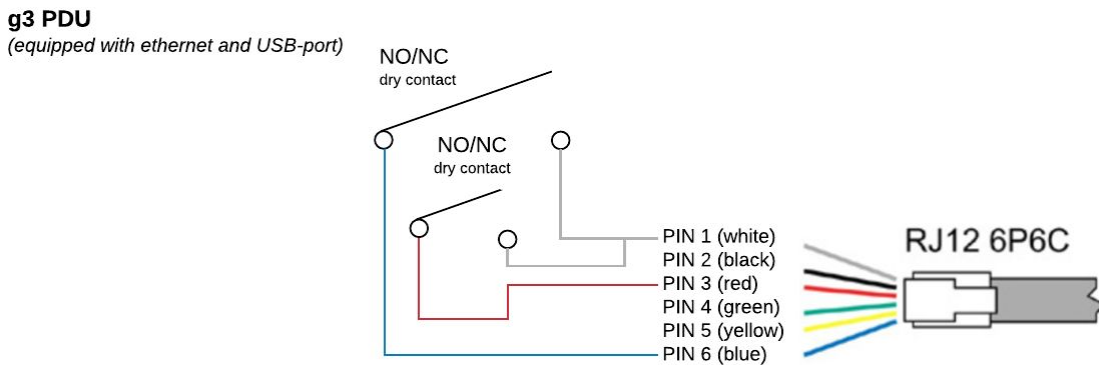

PART II - USER MANUAL

How to maintain a PDU?

A Schleifenbauer Intelligent PDU **may not be opened by unauthorized personnel**. In the event of malfunction or faults in the PDU, please refer to the warranty conditions. Schleifenbauer Products BV will not accept warranty claims if the PDU has been opened or alterations have been made.

- *Please pay attention to the operation conditions before installation and operation of the Schleifenbauer PDU.*
- *The Schleifenbauer PDU has to be protected according to the valid installation guidelines. The rated value of the in-series protective device may not exceed the maximum value indicated on the product.*
- *The Schleifenbauer PDU may not be used in: a humid environment, a seriously contaminated environment or outdoors.*
- *The manufacturer's warranty on the Schleifenbauer PDU becomes invalid when the QC sticker on the side of the profile is broken.*
- *Before turning on the PDU for the first time, make sure that it has been allowed to acclimatize to the ambient temperature for at least 24 hours. Major temperature fluctuations can lead to the formation of condensation in the PDU if this guideline is not followed.*
- *Please keep in mind that the maximum allowed temperature for a metal enclosure is 70 °C for installation in a normal location and 90 °C for installation in a restricted access location.*

How to be sure the status of switchable outlets will not change during firmware upgrade or restarting of the controller?

The Schleifenbauer PDUs are designed for continuous operation with the power distribution and the control over measuring and switching separated. This means that while updating or restarting the (controller of the) PDUs, power distribution is not interrupted.

LIFE-SUPPORTING POLICY

The Schleifenbauer PDU has been designed for use in data centers where equipment has to meet very high demands especially regarding reliability.

The Intelligent PDU however may not be applied in surroundings where a malfunction in the PDU can have consequences for life support systems.

Life support systems include any devices designated as “critical” by the U.S. FDA. Such systems are found not only in medical environments such as hospitals, but also on offshore platforms, in petrochemical plants, in air traffic control centers, etc.

PART IIA - LOCALLY MONITORING: DEVICE DISPLAY

The intelligent PDU features a display with scroll buttons, LEDs and some ports for connecting accessories. Please keep in mind that PDUs may differ in configuration and may or may not not have a display.

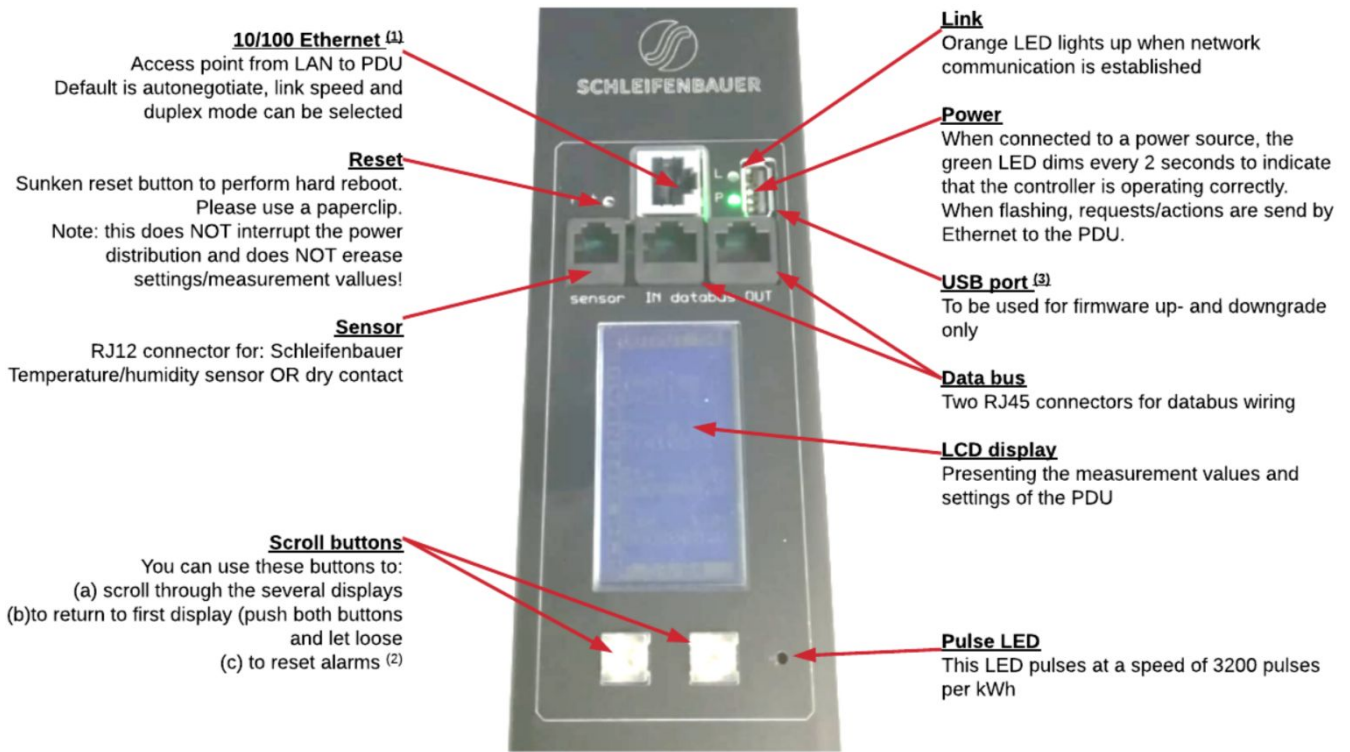

- (1) PDUs **without** an Ethernet port are called Classic PDUs. Firmware for Classic PDUs are in the FW1xxx - range
- (2) This option is called “Local alert reset” and must be activated through the interfaces
- (3) USB-port on g3 (generation 3) only ; to be used for firmware up- and downgrade (from FW2.52 and newer)

How to change settings locally via PDU display?

Changing settings locally via the PDU itself is **not** possible! You have to use one of the interfaces.



See the [Administrator part](#) of this manual how to changes the settings

How to stop a blinking display? Local alert reset

Since FW2.50 alerts are represented on both display and web interface. For example:

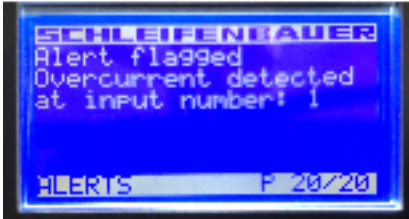

The displayed text shows directly which alert has occurred.

Why do alerts occur?

Alerts are signal flags after an event occurred. For example, if the measured temperature and the environmental conditions exceed a configured level or threshold, the PDU will generate an alert. This resolves in:

- SNMP trap (optional).
- The screen of the PDU will start blinking.
- The screen of the PDU will jump to the Alert page which provides information on what happened.

After the temperature has dropped again, the event is cleared but the alert still exists. The display will blink until you “reset” (=clear) the alert.

The LCD display only flashes when an alert is active.

- Actions:
- press any button to stop blinking for a short period: blinking will stop so you can read the display
 - resetting the alert can be done by pressing both scroll buttons simultaneously; when cleared the display will stop blinking (Note: this possibility must be activated on your device; see Admin part of this manual)



You can reset the alert but by doing so, you do not resolve the cause of the alert!
If the alert condition is still present the alert will reappear.

How to check the load balance, the temperature / humidity or the status of the NO/NC contact?



The image shows three phases (L1, 2 and 3). The actual information is presented in amperes but is also graphically displayed. The higher the load, the more the bar is filled. The graphical bar is related to the maximum PDU rating (in the image it is 32A). In this image, there is almost zero load, only on L3 there is a small 0.1A.

DS = status of NO/NC contact [O = open; C = closed]

Te = temperature [degrees C] *

RH = relative humidity [%] *

*only visible when the corresponding sensor has been connected.

How to get back to the first page?



If there are alerts, first clear these by pressing both scroll buttons (see: "[How to stop blinking display? Local alert reset](#)").

If the alerts are resolved or there are no alerts (no blinking display), press both scroll buttons (see arrows in image) to quickly jump to the first page.

How to check an outlet status locally?



Note: every row on the display shows the state of nine outlets. So the first ends with outlet nine, the second row starts with outlet ten.

In the "outlets" display you can see how many outlets the PDU has and what their individual state is.

An overview of the possible states:

- 0 = off
- 1 = on
- s = scheduled to go off
- S = scheduled to go ON
- p = power cycling

How to check input and/or outlet measurements?



Example: input page

Note: "Input x" shows the name of the Input. This information can be configured from the Web Interface, Inputs tab or from the other interfaces.

The scroll buttons allow the user to scroll through the pages. The total amount of pages varies and depends on the PDU configuration. For example: the more outlets the higher the total amount of pages. In the "input page" example page four of 29 is displayed. In the lower left corner of the "input page" example, the subject of the shown information on this page is visible as "INPUT L2", which is short for input measurements of L2. So, when you search for outlets, scroll through the pages until the "outlet" sections are reached. An example is shown in the "outlet page" image.



Example: outlet page

Displayed information can be:

- I = current [A]
- P = power [W]
- U = voltage [V]
- Pf = power factor [%] (= real power ÷ apparent power)
- Et = energy total [kW]
- Es = subtotal energy [kW]

How to read measurements of optional sensors and what options are possible?

Option 1: load page

Sensors are displayed on the "Load" screen whenever there are less than three sensors in use. When adding more sensors, one or more pages are added to the display to show the sensor readouts (see image):



DS = status of NO/NC contact [O = open; C = closed]

Te = temperature [degrees C]

RH = relative humidity [%]

Option 2: sensor pages

The sensor measurements are displayed in the following format:

< channel number > < sensor type > = < value >

The sensor type is indicated by a letter. The letters are abbreviations for the sensor type as follows:



Example: sensor page 1 of 2



Example: sensor page 2 of 2

Analog:

T = temperature [°C]

H = humidity [%]

R = residual current [mA]

See "How to read branch residual current measurements"

A = AC residual current [mA]

D = DC residual current [mA]

B = Branch residual current [mA]

Digital:

I = dry switch contact

S = error status

Y = activity

For all optional sensors see www.schleifenbauer.eu

How to read Branch Residual Current measurements?

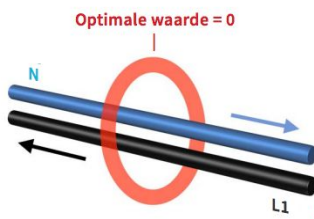

$L1 + L2 + L3 + N > 0 \text{ mA} \dots$ THERE MIGHT BE FAULT IN YOUR SYSTEM !

When the PDU is equipped with a Residual Current Sensor (RCS), measurements of the residual current are shown in the sensor pages.

(See example images in the previous chapter "[Option 2: sensor pages](#)").

In parts of Europe, electrical installations must incorporate devices designed to protect people and prevent fires: the residual current device, or RCD. A RCD disconnects the circuit if the total for the incoming and outgoing currents in the monitored phases and their neutral conductor exceed a threshold, for example : $L1 + L2 + L3 + N > 30 \text{ mA}$

Data center practice: Residual Current Monitoring in relation to Residual Current Devices

Many devices inside a datacenter operate a switching power supply. These power supplies usually leak a bit of energy to the protective earth, so even without failing hardware some residual current will occur. In order to rule out a single dangerous fault from a sum of harmless smaller faults, one needs to set up a network of RC-sensors and monitor them permanently. RC-monitoring can take place in many forms. The Schleifenbauer RC-sensor offers Class B metering, thus enabling our customers to set-up an RC-monitoring system that prevents dangerous situations inside the datacenter.

Where to measure residual current?

When monitoring residual current at a single location it is not possible to determine whether the measured value is a sum of many small currents or a single larger (dangerous) one. For that reason it contributes to the safety of the personnel inside a data center when residual currents are metered at several points.

How to find the PDUs unit address, tag, name or location?



You will find all customer specific information about the PDU in the "Custom" display.

- Adr = address of this unit on the databus
- Tag = vanity tag
- Nme = device name
- Loc = location of the device

The device name and tag can be changed using the WEBAPI. See the admin manual [Part IIB - Remote operating and monitoring: Web interface](#) for more details.

How to view PDU connection information?

```
SCHLEIFENBAUER
Lnk:100M Full-duplex
St :IPv6 configured
IP :192.168.9.161
NM :255.255.255.0
GW :192.168.9.254
MAC:D0-22-12-B0-7A-FC
IPv4 LINK P 17/21
```

```
SCHLEIFENBAUER
#1:FE80::D222:12FF:FE
B0:7AFC
#2:CAFE::D222:12FF:FE
B0:7AFC
#3:::
IPv6 LINK P 18/21
```

You will find all information related to the PDUs network connection in the IPv4 Link and IPv6 Link pages.

IPv4Link:

- Lnk = current Ethernet link status of the device
- St = IP status:
 - DHCP: Acquiring/Bound, Static, Static fallback
 - ‘-‘ when there is no link
- IP = IP address of the device
- NM = subnet mask of the device
- GW = IP address of the Gateway or Router
- MAC = MAC address of the device

The IPv6 link will show up to 3 IPv6 addresses. The first one will be your link-local address which will always start with FE80:: the second and third will be your LAN and WAN address respectively.

How can I check in which mode and with what protocol the PDU is running?

```
SCHLEIFENBAUER
Mode :Bridge
HTTP :TCP/80
API :TCP/7783
Modbus:TCP/502
SNMP :UDP/161 v2+v3
IPMode:IPv4+IPv6
IP INTERFACES P 19/21
```

In the “IP Interfaces” display you can find information about the device mode in which the PDU is working:

- Mode = hybrid, databus, bridge, colocation, ...



See the chapter “[Schleifenbauer databus: what is it?](#)” in this manual for explanations of the term hybrid, bridge, ...

The display shows the status, and which protocol & port number is used for:

- HTTP
- API
- Modbus
- SNMP
- IPMode (IPv4, IPv6 or both)



When there is active communication with the PDU, the interface colors will be inverted. Text is white and the background is blue. When the interface is used, the text becomes blue and the background white.

How to check the installed firmware version?

```
SCHLEIFENBAUER
Ver:02.50-18082115C01
ID :02431-06521-00000
SN :SUNL00056484
Prt:ESENVIB1103-002
Ord:2017-35140
Ph :1 0:12 S:12 M:12
#8001 P 20/21
```

In the “About” page you can find the firmware version that is currently installed on the device. In this example the firmware version is FW02.50.



It is important that the most recent firmware version is installed on all devices. This ensures correct operation of the device and databus. Firmware and service tools can be found at “downloads” on the Schleifenbauer website.

How to check for traceability information ?

```
SCHLEIFENBAUER
Ver:02.50-18082115C01
ID :02431-06521-00000
SN :SUNL00056484
Prt:ESENVIB1103-002
Ord:2017-35140
Ph :1 0:12 S:12 M:12
#8001 P 20/21
```

In the “About” page you can also find information regarding serial number, product information and Schleifenbauer order number.

- ID = unique hardware address of this device’s controller
- SN = serial number (also found on the PDU housing)
- Prt = product identification (also found on the PDU housing)
- Ord = order number for internal Schleifenbauer uses
- Ph = number of phases of this device
- O = total number of outlets on this device
- S = number of switchable outlets on this device.
- M = number of metered outlets on this device

PART IIB - REMOTE OPERATING AND MONITORING: WEB INTERFACE

Introduction

Schleifenbauer PDUs allow remote administration which enables users to switch on or off selected outlets, monitor usage data and set/receive alerts on configured thresholds. In addition various connection parameters can also be configured through various protocols.

The web interface is an easy to use tool to configure the PDU. This chapter gives an overview of the different possibilities.

Login

By default the web interface is enabled. To navigate to the web interface the IP address and port number can be found on the display of the PDU.

How to select English or German language?



The login screen lets the user choose between English or German language.

Note: in this manual, only the English screens will be shown.

How to enlarge a pane in L sized screens?

There are two possibilities:

- using the pane separator:
- using the < or > signs :

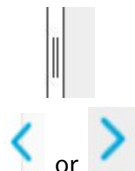

User interface

 Connected devices
(ONLY IN BRIDGE MODE)

The left pane of the image below shows a list of connected devices on the databus. Also the databus management functions can be found in this section such as:

- Scan databus
- Initialise zero addresses to sequence
- Reset all alerts

 Device information

After selecting a connected device, you see measurements/information and get access to the remote operating functions, in the right pane.

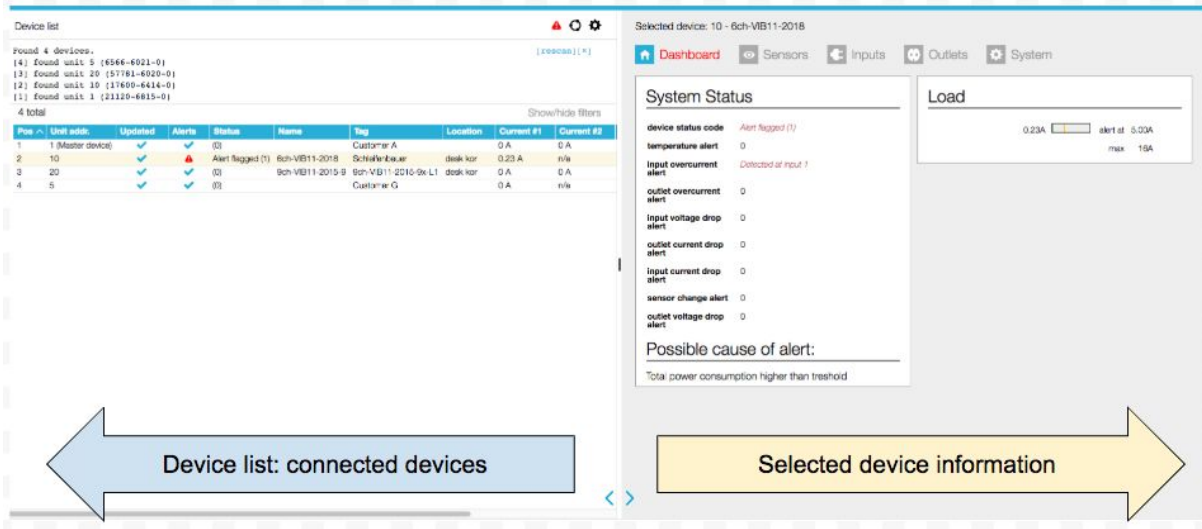

The screenshot shows a web interface with two main panes. The left pane, titled 'Device list', contains a table of connected devices. The right pane, titled 'Selected device: 10 - 6ch-VB11-2018', displays system status, alerts, and a load gauge. A blue arrow points to the device list, and a yellow arrow points to the selected device information.

Pos	Unit addr.	Updated	Alerts	Status	Name	Tag	Location	Current #1	Current #2
1	1 (Master device)	✓	✓	03			Customer A	0 A	0 A
2	10	✓	✗	Alert flagged (1)	6ch-VB11-2018	Schleifenbauer	desk hor	0.23 A	n/a
3	20	✓	✓	03	6ch-VB11-2018-B	6ch-VB11-2018-Gk.L1	desk hor	0 A	0 A
4	5	✓	✓	03		Customer G		0 A	n/a



It is recommended to only use a single connection to the PDU serving the webinterface. With multiple connections open the network traffic on the serving PDU and any PDUs connected through the databus will increase while response time will decrease. Therefore it is NOT advisable to open too many web interfaces in order to prevent “hammering” the databus.

How to change and save settings in the web interface?

 Locked

 Editable

The web interface is protected against accidentally changing settings. Related to your user profile, you might have permission to change information: see the “Permission model”. To open protected cells, you first have to click the “Locked” sign and the status will change to “Editable”.

When ready, click “Editable” or click the “Save changes” icon if shown, and the sign will turn into “Locked”.

DASHBOARD – TAB

The dashboard tab shows general PDU information. Example screenshots are shown below.

Selected device: Master device - 6ch-VIB11-2018

Dashboard Sensors Inputs Outlets System Interfaces

System Status

device status code	OK (0)
temperature alert	0
input overcurrent alert	0
outlet overcurrent alert	0
input voltage drop alert	0
outlet current drop alert	0
input current drop alert	0
sensor change alert	0
outlet voltage drop alert	0

Load

L1 0,10A  alert at 5.00A
max 16A

Interfaces

network state	IPv6 Link configured
device mode	bridge
webserver	enabled
API	enabled
modbus TCP	enabled
SNMP	enabled

System status

Dashboard Sensors

System Status

device status code	Alert flagged (1)
temperature alert	0
input overcurrent alert	Detected at input 1
outlet overcurrent alert	Detected at outlet 9
input voltage drop	0

Possible cause of alert:

Total power consumption higher than threshold

This section gives you a quick view of the actual state of the PDU: are there any alerts? And if yes, which alerts, and what caused them?



The number following after “drops” and “overcurrent” shows the OUTLET NUMBER of the last alert. In this example there is an “outlet overcurrent” at outlet number nine.













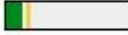

When enabled “Auto reset alert”, alerts will be automatically cleared after the chosen time without active alert conditions.

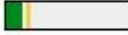

When an alert occurs, the tab name “Dashboard” turns red (see example on the left) .

The name “Dashboard” also turns red when switching devices in the device list.

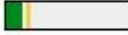



Looking for the reason why an alert occurred? In the <System Status> box the PDU gives you a possible cause of the alert.

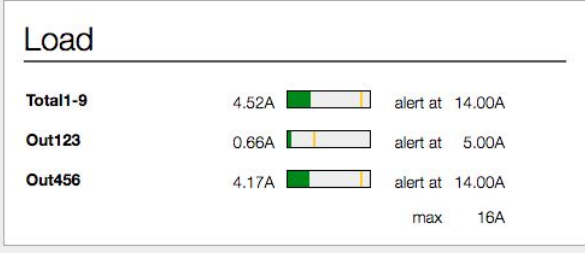

9

Device status code	<p>The code shows the status of the device in terms of errors:</p> <p>0 OK Device status is OK.</p> <p>1 Alert flagged One or more alerts have been flagged. Please check the other alert fields to see the cause of the alert. It can be one of the following sources:</p> <ul style="list-style-type: none"> ◆ temperature alert ◆ input current alert ◆ output current alert ◆ input voltage alert ◆ output current drop alert ◆ input current drop alert ◆ sensor change alert <p>2 Setting(s) initialized Some settings have been reset to default values. This may occur after a factory reset or a firmware upgrade.</p> <p>4 Power-on reset The device has rebooted after a power loss. It can be one of the following reasons:</p> <ul style="list-style-type: none"> • because of inserting the PDU power plug (mostly intentional. It can be unintentional if someone removed the power plug accidentally) • because of a power outage (unintentional), • because of a defect in the internal power supply. <p>8 External reset The device has been reset by pressing the reset button on the unit.</p> <p>16 Watchdog timer The device rebooted due to an internal error.</p> <p>32 Brownout detected Device rebooted because a voltage drop has been detected. This may indicate a defect in the internal power supply or a dip in external power supply.</p> <p>64 Controller error A hardware error has been detected.</p> <p>128 Slave reset A communication issue has been detected with an outlet slave module.</p>									
temperature alert ⁽¹⁾	Temperature alert raises for temperatures, which exceed the user's maximum temperature setting. '0' indicates proper functioning.									
input overcurrent alert ⁽¹⁾	<p>Input current alerts occur for inputs/lines/phases which exceed the user's maximum current setting for that input. When multiple inputs are in alert state, only the alert which appeared first is shown.</p> <p> 0 = OK, "Detected at input 1" => there is/was an input/line/phase current alert at phase/line 1</p> <table border="1" data-bbox="363 1290 890 1704"> <tr> <td colspan="2">There still is an input overcurrent:</td> <td rowspan="2">The threshold of an input can be changed at the tab < Input >. The threshold itself is displayed in the horizontal bar (vertical yellow line). When exceeding the threshold, the color of the bar turns red (see example on the left)</td> </tr> <tr> <td colspan="2"> <p><u>Load</u></p> <p>L1 8.00A  alert at 5.00A</p> <p>L2 0.00A  alert at 5.00A</p> <p>L3 0.00A  alert at 5.00A</p> <p style="text-align: right;">max 32A</p> <p>In the example above there still is an overcurrent on input L1 => RED bar</p> </td> <td>When the overcurrent is resolved, the red bar turns green. This means there is an input current; in the example below it is 4.12A</td> </tr> <tr> <td colspan="2"></td> <td style="text-align: center;">4.12A  alert at 5.00A</td> </tr> </table>	There still is an input overcurrent:		The threshold of an input can be changed at the tab < Input >. The threshold itself is displayed in the horizontal bar (vertical yellow line). When exceeding the threshold, the color of the bar turns red (see example on the left)	<p><u>Load</u></p> <p>L1 8.00A  alert at 5.00A</p> <p>L2 0.00A  alert at 5.00A</p> <p>L3 0.00A  alert at 5.00A</p> <p style="text-align: right;">max 32A</p> <p>In the example above there still is an overcurrent on input L1 => RED bar</p>		When the overcurrent is resolved, the red bar turns green. This means there is an input current; in the example below it is 4.12A			4.12A  alert at 5.00A
There still is an input overcurrent:		The threshold of an input can be changed at the tab < Input >. The threshold itself is displayed in the horizontal bar (vertical yellow line). When exceeding the threshold, the color of the bar turns red (see example on the left)								
<p><u>Load</u></p> <p>L1 8.00A  alert at 5.00A</p> <p>L2 0.00A  alert at 5.00A</p> <p>L3 0.00A  alert at 5.00A</p> <p style="text-align: right;">max 32A</p> <p>In the example above there still is an overcurrent on input L1 => RED bar</p>			When the overcurrent is resolved, the red bar turns green. This means there is an input current; in the example below it is 4.12A							
		4.12A  alert at 5.00A								
outlet overcurrent alert ⁽¹⁾	<p>Outlet OVERCURRENT alert raises for outlet number</p> <p>When multiple outlets are in alert state, the highest outlet will be indicated</p> <p> 0 = OK, "Detected at outlet 9" means that there was a current drop at outlet "9"</p>									

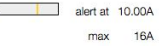
input voltage drop alert ⁽¹⁾	<p>This alert occurs when the voltage on an input/line/phase drops below normal operating range, even if the drop is very short (30ms).</p> <p>When multiple inputs are in alert state, only the alert which appeared first is shown.</p> <p> 0 = OK, "3" means that there was an input/line/phase voltage alert at phase 3</p>
outlet current drop alert ⁽¹⁾	<p>Outlet drop alert raised for outlet number ...n.. .</p> <p>When multiple outlets are in alert state, only the highest outlet will be indicated.</p> <p> 0 = OK, "22" means that there was a current drop at outlet "22"</p>
input current drop alert ⁽¹⁾	<p>Input current drop alerts occur due to a sudden current drop for an input. When multiple inputs are in alert state, only the highest input will be indicated.</p> <p>'0' is the indication of proper functioning.</p>
sensor change alert ⁽¹⁾	<p>Sensor change alerts occur when a sensor type has been changed. If multiple sensor types have been changed the lowest sensor channel will be shown.</p> <p>'0' is the indication of proper functioning.</p>
outlet voltage drop alert ⁽¹⁾	<p>Outlet voltage drop alerts occur for outlet number ...n.. .</p> <p>When multiple outlets are in alert state, only the highest outlet will be indicated.</p> <p>The threshold is set on 80% of the provided input current. This ensures proper functioning in different countries.</p> <p> 0 = OK, "22" indicates a current drop at outlet "22"</p>

- (1) Only the first alert is flagged
- Input overcurrent thresholds can be changed at the < Inputs > tab
- Outlet overcurrent thresholds can be changed at the < Outlets > tab
- General alert setting can be changed at the < System > tab

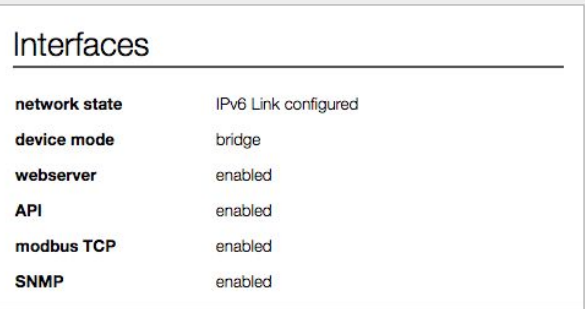
<p>Load</p>		<p>Shows the name, load and alert threshold of each input.</p> <p> <i>The way loads are visualised depend on the thresholds set in the configuration of the PDU. See tab < Input > when you want to change the name of an input.</i></p>
<p>Load</p> <p>Total1-9</p> <p>Out123</p> <p>Out456</p>	<p>By default, the name field has an 8 character limit. With the “extended name”-option enabled, the name field can contain 18 characters.</p> <p>➤ See also chapter: System tab > Settings</p>	
<p>8.54A </p>	<p>In a graphical bar the current load is visualized. As long as the load is under the “alert threshold” the bar will be green.</p>	
<p>0.00A  alert at 10.00A max 16A</p>	<p>The alert threshold is visualised as a yellow, vertical line.</p> <p>➤ See also chapter: System tab > Settings</p>	
<p>17.06A </p>	<p>However, when the load passes the alert threshold, the bar will turn red. Exceeding the alert threshold results in two events:</p> <ol style="list-style-type: none"> 1) an alert occurs in the “System status” block <ul style="list-style-type: none"> ➤ See also chapter: Web Interface > Dashboard tab > System status 2) at the same time the display of the PDU will blink <ul style="list-style-type: none"> ➤ See also chapter: Operating the PDU > Alerts: blinking display 	

<p>Interfaces</p>		<p>Data shown is read-only and gives an overview of the statuses of the interfaces.</p> <p> <i>This block is only shown for devices in BRIDGE mode</i></p>
--------------------------	---	---

SENSORS – TAB

When sensors are connected to the PDU the sensors tab allows the user to read the measurements and attach names to the sensors.

Selected device: Master device -

[Dashboard](#)
[Sensors](#)
[Inputs](#)
[Outlets](#)
[System](#)
[Interfaces](#)

Sensors 4 total 🔒 Locked

#	name	type	value
1		dry switch contact	0
2		dry switch contact	0
3		temperature	26.71 °C
4		humidity	35.38 %

name	By default, the name field has an 8 character limit. With the “extended name”-option enabled, the name field can contain 18 characters. ➤ See also chapter: System tab > Settings
type	Shows the sensor type. This is detected automatically. ➤ See also chapter: Operating the PDU > description of display screens > Sensor page(s)  G3 devices - equipped with an USB port - can handle two dry switch contacts (see example image above)
value	Shows the actual sensor value.

INPUTS – TAB

Selected device: Master device -

[Dashboard](#)
[Sensors](#)
[Inputs](#)
[Outlets](#)
[System](#)
[Interfaces](#)

Inputs 3 total

Locked

#	name	kWh total	subtotal	power (VA)	power (W)	PF	current	peak current	voltage	min voltage	overcurrent alert at
1	L1	0	0.082	0	0	100.00	0.00	8.05	229.11	223.52	5.00
2	L2	1	0.080	0	0	100.00	0.00	8.07	228.79	223.21	5.00
3	L3	14	0.018	0	0	100.00	0.00	8.02	228.99	223.17	5.00

#	This indicates the number of input phases. In this example, there are three inputs because a three phase PDU is shown. A single phase PDU will show only one input.
name	By default, the name field has an eight character limit. With the “extended name”-option enabled, you can make use of 18 characters. Whether users are allowed to modify names depends on their user role according to the “permission model” ➤ See also chapter: “web interface > permission model” & “System tab > Settings”
kWh total	Total amount of energy per line. Important: These values can not be reset during the lifetime of the devices.
subtotal / reset	Total amount of energy per line since the last reset. This value is reset by “unlocking” and clicking the “reset” button.
power [VA]	Apparent power per line
power [W]	Real power per line
PF	Power factor per line [%] = real power [W] / apparent power [VA]
current	Actual current [A] per line
peak current	Highest current per line since the last “reset peaks and dips” ➤ See also chapter: System tab > Reset
voltage	Actual voltage [V] per line
min voltage	Lowest measured voltage (dip) [V] since the last “reset peaks and dips” ➤ See also chapter: System tab > Reset
overcurrent alert at	Field in which the maximum current [A] is configured for this line, what the actual current is allowed to reach. Exceeding this limit will cause an alert. ➤ See also chapter: System tab > Reset & Settings

OUTLETS – TAB

Selected device: Master device -

[Dashboard](#)
[Sensors](#)
[Inputs](#)
[Outlets](#)
[System](#)
[Interfaces](#)

Outlets 48 total 54 switchable 54 metered

Locked

#	name	kWh total	subtotal	power (VA)	power (W)	PF	current	peak current	voltage	overcurrent alert at	individual delay	power cycle time	state	
1		0 0	reset	0	0	100.00	0.00	0.00	229.22	14.00	0	5	on	unlock
2		0 0	reset	0	0	100.00	0.00	0.00	228.76	14.00	0	5	on	unlock
3		0 0	reset	0	0	100.00	0.00	0.00	228.67	14.00	0	5	on	unlock
4		0 0	reset	0	0	100.00	0.00	0.00	228.49	14.00	0	5	on	unlock

#	This tab gives an overview of the configuration of the PDU. In this example, there are 54 outlets in total of which 54 are both switchable and metered. <i>The example shows only the first 5 lines, in reality the screen shows 54 lines, one for each outlet!</i>
name	By default, the name field has an eight character limit. With the “extended name”-option enabled, 18 characters can be used. Whether you are allowed to change the names, depends on the user role according to the “permission model” ➤ See also chapter: “web interface > permission model” & “System tab > Settings”
kWh total	Total amount of energy per line: value cannot be reset during the lifetime of the devices!
subtotal / reset	Total amount of energy per line since the last reset. This value is reset by “unlocking” and clicking the “reset” button.
power [VA]	Apparent power per outlet. <i>Note: not available on Classic PDU (= without Ethernet port) or DPM27</i>
power [W]	Real power per outlet. <i>Note: not available on Classic PDU (= without Ethernet port) or DPM27</i>
PF	Power factor per outlet [%] = real power [W] / apparent power [VA].
current	Actual current [A] per line.
peak current	Highest current per line since the last “reset peaks and dips”. ➤ See also chapter: System tab > Reset
voltage	Actual voltage [V] per outlet.

alert current	<p>Field in which the maximum current [A] that the actual current is allowed to reach is configured for this outlet. Exceeding this limit will lead to an alert.</p> <p>➤ See also chapter: System tab > Reset & Settings</p>
delay	<p>This function provides the option to switch outlets in an user defined manner during startup (if configured). The outlets are switched one-by-one and not all at once. The time interval in which outlets are switched is configurable in seconds.</p>
power cycle time	<p>Configurable downtime when an outlet is power cycled. Which means that after the command to power cycle (shut outlet off and start again) is given, the outlet will be switched on again after the configured downtime has passed.</p> <p>➤ See "Unlock" at the end of this table</p>
state	<p>Shows the configured or actual outlet state depending on the hardware model. There are several possibilities:</p> <div data-bbox="379 772 687 981" style="background-color: #fff9c4; padding: 5px; border: 1px solid #ccc;"> <p>current state</p> <ul style="list-style-type: none"> on on off off son scheduled to switch on sof scheduled to switch off pc power cycling </div> <p>➤ See "Unlock" at the end of this table</p> <div data-bbox="360 1064 419 1115" style="color: red; font-size: 2em;">⚠</div> <p style="color: red;"><i>For devices built from February 2018 on: the displayed outlet state is the actual state because of the implementation of new hardware that enables readout of the actual state of the outlet. Depending the "power up/down outlet behaviour" you can see changes in the overview.</i></p> <p style="color: red;"><i>Devices built up to and including January 2018: the displayed outlet state is the expected user configured state.</i></p>
unlock	<p>After the "unlock" sign is clicked, a confirmation is needed to change the state of the outlet. There are two options:</p> <div data-bbox="391 1417 730 1480" style="border: 1px solid #ccc; padding: 5px; margin: 10px 0;"> <div style="display: flex; justify-content: space-around;"> switch off power cycle </div> </div> <ul style="list-style-type: none"> ● Switch off ● Power cycle (See "power cycle time" in this table) <p>After you have made a choice, the state of the outlet is changing (See "state" in this table)</p> <p>While the given command is processed, a status bar shows the progression of the action.</p> <div data-bbox="379 1720 730 1771" style="border: 1px solid #ccc; padding: 5px; margin: 10px 0;"> <div style="display: flex; align-items: center;"> 20 pc power cycling </div> </div>

SYSTEM – TAB

The screenshot displays the 'SYSTEM' tab of a web interface, which is locked. The navigation bar at the top includes 'Dashboard', 'Sensors', 'Inputs', 'Outlets', 'System', and 'Interfaces'. The 'System' tab is active and highlighted.

Identification (Locked):

- unit address: 1 (with 'Set Address' button)
- firmware version and build: 251 - 180926154532
- SPDM version: 250
- sales order number: 2018-35500
- product ID: SDPEVM1302-001
- serial number: SVNLC0061921
- hardware address: 21120-6815-0
- device name: (empty field)
- device location: (empty field)
- vanity tag: Customer A

Configuration (Locked):

- number of phases: 3
- number of outlets: 48
- number of switchable outlets: 54
- number of metered outlets: 54
- maximum load (A): 32
- number of sensors: 4

Reset (Locked):

Restart CPU will not affect any outlet state!

- restart CPU: restart CPU (with warning icon)
- reset alerts: reset alerts (with warning icon)
- reset peaks and dips: reset peaks and dips (with warning icon)
- local alert reset allowed: yes (dropdown)
- auto reset alert: off (dropdown)

Settings (Locked):

- display backlight timeout: 1 minute (dropdown)
- display orientation: horizontal, display at left side (dropdown)
- peak duration (ms): 1000
- current drop detection: always off (dropdown)
- system-wide outlet delay (ms): 150
- power up/down outlet behavior: use system-wide outlet delay (dropdown)
- outlet unlock override: disabled (dropdown)
- maximum temperature (°C): 50
- sensor change alert: disabled (dropdown)

On the next pages the different sections of the system tab are described.

Identification

Identification 🔒 Locked

unit address

firmware version and build 251 - 180926154532

SPDM version 250

sales order number

product ID

serial number

hardware address 21120-6815-0

device name

device location

vanity tag

Identification and allocation information of the device

unit address	Address of the device on the databus (see chapter Schleifenbauer databus). Number can be between 1 and 65535 (When using Modbus, number can be between 1 and 247).
firmware version	Current firmware version installed on the PDU. ➤ Please check the website for the latest version: www.schleifenbauer.eu
SPDM version	The actual version of the Schleifenbauer Products Data Model.
sales order number	Reference of initial Schleifenbauer sales order number.
product ID	Product identification tag of the device.
serial number	Unique, sequential production number.
hardware address	Unique identification of the device controller.
device name	Configurable device name, which has a maximum of 16 characters. <i>Note: this field is not connected with the "extended name support" and is always max 16 characters</i>
device location	Configurable location name, which has a maximum of 16 characters. <i>Note: this field is not connected with the "extended name support" and is always max 16 characters</i>
vanity tag	Configurable vanity tag, which has a maximum of 20 characters. <i>Note: this field is not connected with the "extended name support" and is always max 20 characters</i>

<i>Configuration</i>		Configuration	<i>Configuration information of the PDU</i>														
		<table border="1"> <thead> <tr> <th colspan="2">Configuration</th> </tr> </thead> <tbody> <tr> <td>number of phases</td> <td>3</td> </tr> <tr> <td>number of outlets</td> <td>45</td> </tr> <tr> <td>number of switchable outlets</td> <td>45</td> </tr> <tr> <td>number of metered outlets</td> <td>45</td> </tr> <tr> <td>maximum load (A)</td> <td>16</td> </tr> <tr> <td>number of sensors</td> <td>1</td> </tr> </tbody> </table>	Configuration		number of phases	3	number of outlets	45	number of switchable outlets	45	number of metered outlets	45	maximum load (A)	16	number of sensors	1	
Configuration																	
number of phases	3																
number of outlets	45																
number of switchable outlets	45																
number of metered outlets	45																
maximum load (A)	16																
number of sensors	1																
number of phases	Number of input phases/lines.																
number of outlets	Total number of outlets.																
number of switchable outlets	Total number of switchable outlets.																
number of metered outlets	Total number of metered outlets.																
maximum load [A]	Maximum current of the loads (per phase or line).																
number of sensors	Shows the total number of sensors detected. <i>Note: The system automatically detects the presence or removal of sensors.</i>																

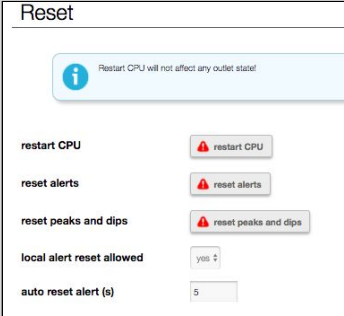
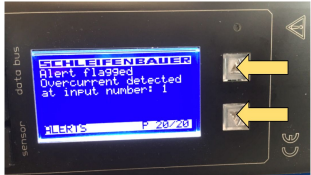
<i>Reset</i>		Reset	<i>Restart PDU and all alerts are reset.</i>
			
restart CPU	This is a reboot of the controller of the PDU. After restarting all alerts and peak registrations will be erased. Be assured: power distribution will NOT BE INTERRUPTED during this restart!		
reset alerts	Clears all the alerts on the device. Of course resetting alerts does not mean that the cause of the alert is resolved. An unresolved alert can occur directly after resetting.		
reset peaks and dips	Clears all the registered peaks and dips on the device.		
local alert reset allowed	Provides the ability to clear alerts on the PDU by pressing both “Page up” and “Page down” buttons (next to the display) at the same time.		
			

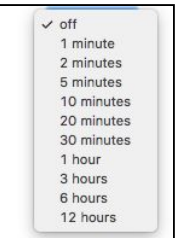
auto reset alert (s)	<p>In this drop-down menu, the user chooses how much time it will take to automatically clear alerts after the alert condition disappears.</p> <p>Be sure that alerts are registered by your management software.</p>	
----------------------	---	---

Settings

Settings

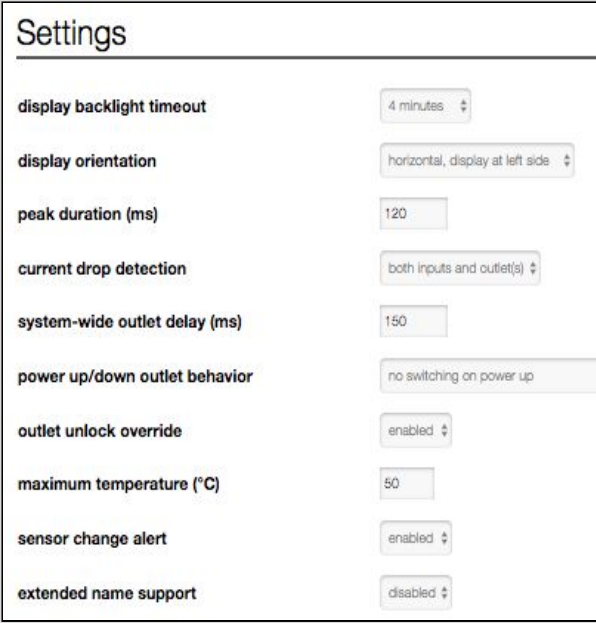

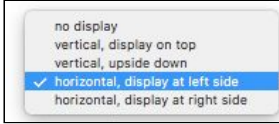
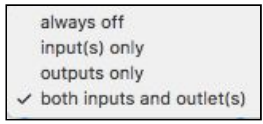

The available settings differ depending on the PDU model. The settings on your PDU can differ from the settings shown in the image.

display backlight timeout	Setting for switching off display backlight after certain set time:	
display orientation	Setting for the orientation of the display on the PDU. This feature allows the display orientation to be set correctly independent of the mounting orientation of the PDU itself. It can be set as:	
peak duration [msec]	Configurable time in milliseconds a current overload is allowed to occur before an alert is given. <i>Note: we advise to prevent setting this time too short because this results in massive amounts of alerts.</i>	
current drop detection	<p>In this drop-down menu, you can select which current drops must be detected. Please note that current drop detection is working as follows: When the actual current of a channel (can be input or metered outlet) is above 0.5A (500mA) and drops with more than 50% of its value, then an input/ outlet current drop alert occurs.</p> <p>For example:</p> <ul style="list-style-type: none"> ● Actual current = 0.4A, drops to 0A -> no alert ● Actual current = 1A, drops to 0.6A -> no alert ● Actual current = 1A, drops to 0.4A -> alert occurs 	

system-wide outlet delay [msec]	Value for delay time between two switch actions in milliseconds. The default value is 100 milliseconds. Please note that values below 100 milliseconds are not accepted.
power up/down outlet behaviour	<div data-bbox="491 309 1315 651" data-label="Diagram"> </div> <p data-bbox="357 719 1420 904">Auto shut down is factory default on Schleifenbauer PDUs. When power distribution to the PDU fails, all outlets will shut down; which of course leads to shut down of connected servers and other equipment. The function of the auto shut down is to prevent peak currents damaging equipment when the power loss is resolved and power distribution restarts. As a customer you are able to set the power up mode of the outlets.</p> <p data-bbox="357 958 703 987">Outlet behaviour can be set as:</p> <ul data-bbox="411 996 1420 1368" style="list-style-type: none"> <input type="checkbox"/> no switching on power up <ul style="list-style-type: none"> - at power up, all outlets are kept in the off state. This results in the PDU booting up while any power draw on connected devices is prevented. <input type="checkbox"/> use system-wide outlet delay <ul style="list-style-type: none"> - at power up, all the outlets are set one by one to their last known state by respecting the fixed <u>system-wide</u> outlet delay <input type="checkbox"/> use individual outlet delay <ul style="list-style-type: none"> - at power up, all the outlets are set to their last known state, but delayed by the <u>individual</u> outlet delay plus fixed <u>system-wide</u> outlet delay <p data-bbox="357 1402 1372 1462">Please note that an auto shut down will be performed in these three modes. This means all outlets have been switched off in case of power loss.</p> <div data-bbox="371 1507 427 1563" data-label="Image"> </div> <p data-bbox="357 1547 1442 1615">For PDUs built from February 2018 equipped with 6-channel outlet prints, there is an extra option:</p> <ul data-bbox="411 1626 1442 1727" style="list-style-type: none"> <input type="checkbox"/> no switching on power down <ul style="list-style-type: none"> - in this state outlets are not turned off by default on power loss. This option is only available for G3 (2018) hardware.
outlet unlock override	<p data-bbox="357 1771 1385 1839">Setting for overriding the outlet unlock registers. When this setting is enabled outlets can be switched or power cycled without unlocking them first.</p> <p data-bbox="416 1850 1420 1901"><i>Note that this makes it easier for the user to switch outlets using SNMP, Modbus and API, but also makes it easier to switch the wrong outlet.</i></p> <p data-bbox="416 1928 1385 1977"><i>Please keep in mind that this setting isn't valid for the web interface. To be able to make a change through web interface, the relevant part has to be unlocked first.</i></p>

maximum temperature [°C]	The value of the upper limit represents the maximum temperature allowed in Celsius. An alert occurs if the temperature of any connected temperature sensor exceeds the set value. It can be disabled by setting it to '0'.
sensor change alert	Informs sensor related changes in the PDU such as a new sensor, a disconnected sensor or a broken sensor.
extended name support	<p>This feature allows the use of longer names for inputs, outlets and sensors when viewing the web interface or using SNMP when enabled. This setting also affects the names shown on the display.</p> <ul style="list-style-type: none"> • limited to 18 characters • setting is valid for SNMP, the web interface and the LCD display • for API and Modbus, both the original and extended name registers can be simultaneously and independently used. • when the device is configured in bridge mode, all connected devices should support the extended name feature to work properly. <p> <i>When using both Classic and ethernet PDUs in a databus, the extended name support may lead to conflicting situations.</i></p>

<div style="display: flex; align-items: center; justify-content: space-between;"> <div style="background-color: #f0f0f0; padding: 5px;">Locate</div> <div style="border: 1px solid #ccc; padding: 5px; display: flex; align-items: center; justify-content: center;"> <div style="text-align: center;"> <p>Locate 🔒 Editable</p> <hr/> <p><input type="button" value="Blink display"/> <input type="button" value="Stop blinking"/></p> </div> <div style="margin-left: 20px; text-align: right;"> <p><i>Locate a PDU by flashing it's display.</i></p> </div> </div> </div>	
Blink display	This function lets the display of the PDU blink in a heartbeat pattern. Users can easily locate a specific PDU that's placed in a room with multiple PDUs using this function.
Stop blinking	Stops blinking of the PDU display. Blinking can also be stopped by pressing one of the buttons on the PDU.

Note: Firmware 2.62 or newer required.

INTERFACES – TAB

Dashboard
Sensors
Inputs
Outlets
System
Interfaces

Network Status

network state	IPv6 Link configured
IPv4 address	192.168.9.109
subnet mask	255.255.255.0
gateway	192.168.9.254
MAC address	D0:22:12:B0:7A:FD
hostname	Schleifenbauer_SVNLO0056485
IPv6 link-local address	FE80::D222:12FF:FEB0:7AFD
IPv6 address 1	CAFE::D222:12FF:FEB0:7AFD
IPv6 address 2	::

Access Control Locked

Access control is specified in CIDR notation. IP and prefix bits. Any network client that doesn't match one of these rules will be rejected. These settings are shared for HTTP, SNMP, API, Modbus, TCP

0.0.0.0 is replaced with device's active IP. It can be used to limit access to current LAN (0.0.0.0/24)
0.0.0.0 can be used to allow all IPs
0.0.0.0/32 can be used to disable a single entry

web client IP	192.168.9.125
allowed IPv4 range 1	192.168.9.128 /32
allowed IPv4 range 2	192.168.9.128 /32
allowed IPv4 range 3	192.168.9.128 /32
allowed IPv6 range 1	:: /0
allowed IPv6 range 2	:: /0
allowed IPv6 range 3	:: /0

Network Configuration Locked

DHCP & Static IP Settings

Link Speed/Duplex Mode	Autonegotiate
DHCP	enabled
DHCP fallback to static IP	enabled, will fallback to static IP on failure
DHCP fallback delay (s)	10
IPv4 address	192.168.1.220
subnet mask	255.255.255.0
gateway address	192.168.1.1
primary DNS	0.0.0.0
secondary DNS	0.0.0.0
hostname	Schleifenbauer_SVNLO0056485
IP protocol select	IPv4/IPv6 dual-stack
IPv6 address 1	::
IPv6 address 2	::
IPv6 Autoconfigure	enabled
IPv6 fallback to static IP	enabled

Behavior

In colocation mode, some restrictions are applied on data bus access, depending on the variation:

- 'data bus management': data bus can not switch outlets
- 'data bus viewer': data bus can not write, except for identification and firmware upgrade

In colocation mode, firmware upgrades over Ethernet are blocked.

device mode bridge

The sections of this screen are described in specific manuals. These can be downloaded from our website:

www.schleifenbauer.eu

PART III - ADMINISTRATOR MANUAL

SPECIFIC MANUALS

The specific manuals can be found on our download page: <http://documentation.schleifenbauer.eu/Documentation/>

Subject	Purpose
WebAPI documentation	Describes the WebAPI custom authentication and resource requests.
SPDM 2.xx (Schleifenbauer Products Data Model)	List of all registers and their settings.  <i>If you collect data for your DCIM, please use the latest SPDM. There may be changes in register addresses which might lead to “faulty” readings. For every new firmware release an updated data model is published.</i>
SPBUS_protocol	Provides a concrete and clear description for developers who intend to integrate the SPBUS (Schleifenbauer Products BUS) protocol into their (custom) software solutions.
SPAPI (Schleifenbauer Products application programming interface)	Describe a high-level API for SPBUS devices such that users using the API understand how to use it and developers of any API implementation understand the API’s intentions, structure, and design such that they can easily implement, maintain, and extend it where necessary.
APIs tutorial “Getting started with SPBUS”	Guide a developer to one of the SPBUS device interfaces most fit for their purpose.
Modbus	Address scheme, testfile and example can be found on our website
SPST Manual	Manual for our service tool, which is used for providing a visual overview of all connected PDUs, firmware updates and for performing read or write operations on registers.

How to change SNMPv3 settings?

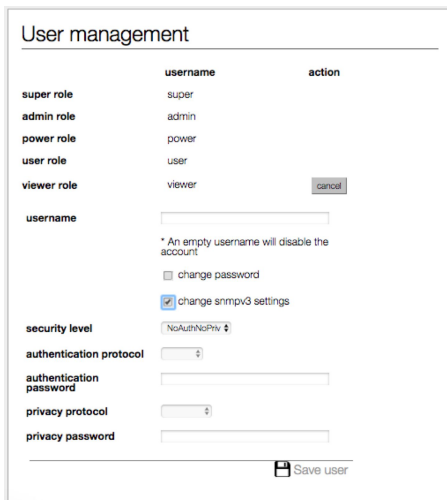

The screenshot shows the 'User management' web interface. It features a table with columns for 'username' and 'action'. Below the table, there are several configuration options for a user:

	username	action
super role	super	
admin role	admin	
power role	power	
user role	user	
viewer role	viewer	cancel

Below the table, there is a 'username' input field. A note states: '*An empty username will disable the account.' Below this, there are two checkboxes: 'change password' (unchecked) and 'change snmpv3 settings' (checked). There is also a dropdown menu for 'security level' set to 'NoAuthNoPriv'. Below these are input fields for 'authentication protocol', 'authentication password', 'privacy protocol', and 'privacy password'. At the bottom right, there is a 'Save user' button.

SNMPv3 user settings can be configured in the web interface: tab "Interfaces", block "User management".

To change the settings of a specific user click the 'edit' button. Then check the 'change snmpv3 settings' checkbox to edit the snmpv3 settings. When finished, click the 'save user' button.



A classic PDU without an ethernet connector that is running on firmware 1.xx doesn't have a device type register. As a result some features do not work using SNMP.

Not working using SNMP on a Classic PDU:

- input subtotal reset per phase
- outlet reboot
- Power (W) and Power (VA), invalid value (0.0)

How to use the 'device list' section in the web interface?

The web interface will show a list of all devices connected to the bridge-PDU on the left pane (or below the blue header when using narrower displays) only when the PDU is configured in Bridge mode. Initially this list is empty but will be filled while the web interface is loading data from the bridge-PDU. A user must click the configuration icon on the right side of the device list and choose "scan data bus". A selected device is marked - yellow line - in the device list (left pane). Users can switch between devices just by clicking the row in the device list. Information and settings about the currently selected device can be seen on the right pane of the web interface. Next to the configuration icon is the ring icon. This icon shows if your ring is properly closed, or if it's open. The example below shows an open ring. The example on the bottom of this page shows a properly closed ring. It's closed by connecting the "out" of the last device in the ring to the "in" of the first device. A closed ring guarantees redundancy of all data between the master "bridge" device and the addressed "hybrid" device.

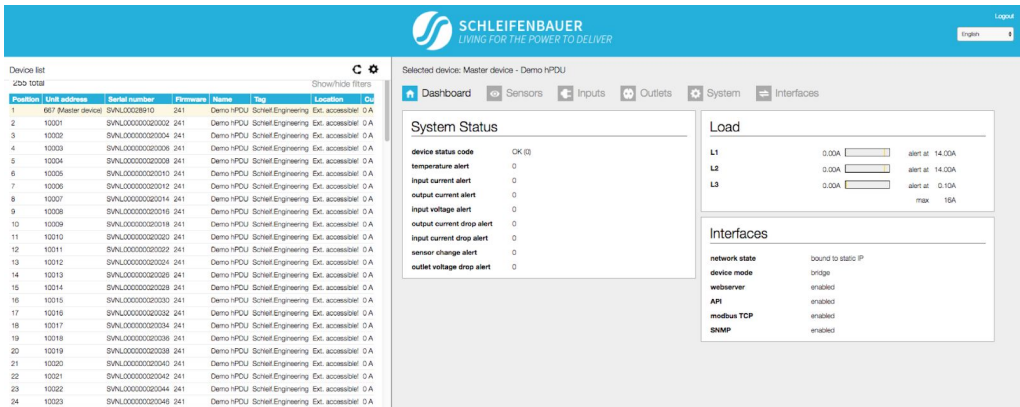

Device list only appears when the connected device is in "bridge" mode.

Note: When using multiple devices in a ring, make sure the one connected to the local network is in bridge mode and all others are in hybrid mode.

How to add new devices on an existing ring? How to solve duplicate devices?

Device list 🔄 ⚙️

Found 4 devices. [rescan][*]

[WARNING] new devices detected on data bus, see below

[WARNING] duplicate devices detected on data bus, see below

[4] found unit 0 (6566-6021-0) [NEW] [set address]

[3] found unit 20 (57781-6020-0)

[2] found unit 10 (17600-6414-0)

[1] found unit 0 (21120-6815-0) [NEW] [set address]



4 total Show/hide filters

Pos ^	Unit addr.	Updated	Alerts	Status	Name
1	0 (Master device)				
2	10	✓	✓	(0)	6ch-VIB11-2018
3	20	✓	✓	(0)	9ch-VIB11-2015-9
4	0 (Master device)	✓	✓	(0)	

When new devices are added to a ring, the firmware might find several devices with unit address 0. **All connected devices require a unique unit address to function properly. Having duplicate unit addresses will result in warnings (see image).**

It is not possible to set all addresses all at once!

In this example, four devices are found. Device [1] is the bridged device so it is best to set this unit address last. So start with [4] which is the device on top in the list that was found first.

<p>Enter new unit address for device with hardware ID 6566-6021-0:</p> <input type="text"/> <p>Cancel OK</p>	<ul style="list-style-type: none"> • click < set address > • a new screen will appear; check if the correct device is selected. • fill in the new < unit address > • Click < ok > <p>A “ write error” will occur which is correct: you just changed the unit address so it can not be reached anymore at its old unit address. Please click <ok></p>																														
<p>Device list  </p> <p>Found 4 devices. [rescan][*]</p> <p>[4] found unit 30 (6566-6021-0) [3] found unit 20 (57781-6020-0) [2] found unit 10 (17600-6414-0) [1] found unit 5 (21120-6815-0)</p> <p>4 total Show/hide filter</p> <table border="1"> <thead> <tr> <th>Pos ^</th> <th>Unit addr.</th> <th>Updated</th> <th>Alerts</th> <th>Status</th> <th>Name</th> </tr> </thead> <tbody> <tr> <td>1</td> <td>5</td> <td>✓</td> <td>✓</td> <td>(0)</td> <td></td> </tr> <tr> <td>2</td> <td>10</td> <td>✓</td> <td>✓</td> <td>(0)</td> <td>6ch-VIB11-2018</td> </tr> <tr> <td>3</td> <td>20</td> <td>✓</td> <td>✓</td> <td>(0)</td> <td>9ch-VIB11-2015-9</td> </tr> <tr> <td>4</td> <td>30</td> <td>✓</td> <td>✓</td> <td>(0)</td> <td></td> </tr> </tbody> </table>	Pos ^	Unit addr.	Updated	Alerts	Status	Name	1	5	✓	✓	(0)		2	10	✓	✓	(0)	6ch-VIB11-2018	3	20	✓	✓	(0)	9ch-VIB11-2015-9	4	30	✓	✓	(0)		<p>When you perform a < rescan > you see that all devices are correctly addressed.</p>
Pos ^	Unit addr.	Updated	Alerts	Status	Name																										
1	5	✓	✓	(0)																											
2	10	✓	✓	(0)	6ch-VIB11-2018																										
3	20	✓	✓	(0)	9ch-VIB11-2015-9																										
4	30	✓	✓	(0)																											

How to configure login profiles, usernames and passwords?

The PDU user authentication model provides five different accounts which can be used to access the web interface and SNMPv3. In the web interface the user accounts are in decreasing order of access rights: super, admin, power, user and viewer. It should be noted that super is only intended for use by Schleifenbauer personnel. The access rights of the different user accounts, together with databus and unauthenticated ethernet, are shown in the table below.

	data bus	super / admin	power	user	viewer	eth unauth.
unit address	x	x				x
name, tag, location	x	x				x
import names	x	x				x
outl. & sens. names	x	x	x	x		x
alert settings	x	x	x			x
reset subtotals	x	x	x			x
switching	x	x	x	x		x
reset alerts / restart	x	x	x	x		x
viewing	x	x	x	x	x	x
FW upgrade	x					x
scan (bridge mode)		x				x
change PDU mode		x				
interface settings		x	x			
IP address		x	x			

The default password for each profile initially equals the username of the profile. For example the default password for the ‘admin’ user profile is “admin”. Each user can change all more restricted user passwords, in addition to their own password. Please fill the ‘Username’ and ‘Password’ fields accordingly and then click login or press enter.

How to change factory passwords?



We advise our customers to change all standard passwords during setup of the system to prevent unauthorized access.

<p>User management</p> <table><thead><tr><th></th><th>username</th><th>action</th></tr></thead><tbody><tr><td>super role</td><td>super</td><td><input type="button" value="cancel"/></td></tr><tr><td>username</td><td><input type="text" value="super"/></td><td></td></tr><tr><td></td><td colspan="2"><small>* An empty username will disable the account</small></td></tr><tr><td></td><td><input checked="" type="checkbox"/> change password</td><td></td></tr><tr><td>new password</td><td><input type="text"/></td><td></td></tr><tr><td>repeat password</td><td><input type="text"/></td><td></td></tr><tr><td></td><td><input type="checkbox"/> change snmpv3 settings</td><td></td></tr></tbody></table>		username	action	super role	super	<input type="button" value="cancel"/>	username	<input type="text" value="super"/>			<small>* An empty username will disable the account</small>			<input checked="" type="checkbox"/> change password		new password	<input type="text"/>		repeat password	<input type="text"/>			<input type="checkbox"/> change snmpv3 settings		<p>In the tab “Interfaces”, section “User management”, passwords can be changed.</p> <p>There are five login profiles:</p> <ol style="list-style-type: none">1. Viewer = viewing only2. User = viewer + resetting alerts and switching outlets3. Power = user + resetting subtotals4. Admin = all administrator rights <p>And the “factory profile”: Super</p>
	username	action																							
super role	super	<input type="button" value="cancel"/>																							
username	<input type="text" value="super"/>																								
	<small>* An empty username will disable the account</small>																								
	<input checked="" type="checkbox"/> change password																								
new password	<input type="text"/>																								
repeat password	<input type="text"/>																								
	<input type="checkbox"/> change snmpv3 settings																								

How to change the Ethernet link settings?

The “ethernet link speed and duplex mode”-setting is set to **auto negotiate** by default. The link speed and duplex mode are automatically configured with the link partner (e.g. Network Switch).

You can also configure the link speed and duplex mode to a fixed setting. You can choose from the following options:

- Autonegotiate
- 10 Mbps Full Duplex
- 10 Mbps Half Duplex
- 100 Mbps Full Duplex
- 100 Mbps Half Duplex

Network Configuration 🔒 Editable

DHCP & Static IP Settings 💾 Save Changes

Saving these settings will reset Access Control settings.
Settings will be effective after restart of CPU or replug of ethernet cable.

Link Speed/Duplex Mode Autonegotiate ▾



When this setting is changed, make sure the configuration of the link partner is changed accordingly!
Deviations in speed/duplex modes prevent users from connecting to the PDU remotely.
If this setting is changed to an invalid value by accident and users are unable to connect, change the setting of the link partner to the same setting in the PDU to be able to access the PDU again. If this doesn't solve the problem: Try a factory reset.

NETWORK CONFIGURATIONS

DHCP and default address

In general, the Dynamic Host Configuration Protocol (DHCP) protocol can dynamically configure the:

- IP address, subnet mask, gateway address, Domain Name System (DNS) servers

By default, the PDU is configured to get the IP address from DHCP automatically. If the PDU does not receive an IP address within a set time, it will proceed using the default address (that needs to be configured manually as devices only start to function when their IP is unique):

192.168.1.220
(subnet mask: 255.255.255.0)

How to change the hostname?

It's possible for users to change the hostname of their devices. A hostname consists of a Schleifenbauer prefix and the serial number by default. There are three options: custom hostname, Schleifenbauer prefix combined with a sysname, or the default. These options are available in the "Interfaces" section of the web interface.

Custom hostname: Change the hostname value, save and restart PDU.

Schleifenbauer prefix and sysname: Add custom name to sysname value, save and restart.

Back to default value (Schleifenbauer prefix and serial number): Empty sysname value, save and restart. Or empty hostname first and then empty the sysname.

How to configure the IP settings manually?

The IP settings can be manually configured by using the web interface:

The screenshot shows the Schleifenbauer web interface. The top navigation bar includes Dashboard, Sensors, Inputs, Outlets, System, and Interfaces. The main content area is divided into two panels: Network Status and Network Configuration. The Network Status panel shows: network state (bound to static IP), IP address (192.168.9.221), subnet mask (255.255.255.0), gateway (192.168.9.254), and hostname (Schleifenbauer_SVNL00028910). Below this is an Access Control section with a 'Locked' status and a text box explaining CIDR notation. The Network Configuration panel shows DHCP & Static IP Settings, with DHCP disabled, DHCP fallback to static IP enabled, and DHCP fallback delay set to 60 seconds. Other settings include IP address (192.168.9.221), subnet mask (255.255.255.0), gateway address (192.168.9.254), primary DNS (192.168.9.254), secondary DNS (0.0.0.0), and hostname (Schleifenbauer_SVNL00028910).

- Actions:
- go to the <web interface>, tab < Interface >, block < Network Configuration >.
 - disable DHCP.
 - Fill in the "Static IP Settings".
 - Restart the CPU: go to tab < System >, block "Reset".



When using 'DHCP fallback to static IP', it is recommended to enter a unique IP address for each PDU. This fallback, when configured correctly, ensures that all PDUs are individually reachable in case of a faulty DHCP server. This prevents PDUs from being assigned to the same IP address.

How to setup IPv6?

Since firmware version FW2.44, IPv6 support has been introduced in the Schleifenbauer PDU. This feature is disabled by default.

An IPv6 address¹ consists of 8 blocks of 4 hexadecimal digits² separated by columns (:). Consecutive blocks of zeroes can be substituted with a double column (::) and leading zeroes can be omitted. The default static IP is "::" which translates to 0000:0000:0000:0000:0000:0000:0000:0000.

IPv6 Autoconfigure (SLAAC)

By default the PDU will try to obtain its IPv6 address through a process called "stateless local address auto configuration" (SLAAC). This setting can be turned off in the web interface by setting "IPv6 Autoconfigure" to "disabled". The PDU will try to find a router by sending router solicitation packets via ICMP6 using its link-local address. This means that a IPv6-enabled router must be available on the network and it must send ICMP6 router advertisement packets in order for the PDU to obtain a valid IP6 address. When "IPv6 fallback to static IP" is set to enabled in the web interface, the PDU will use its configured static addresses as fallback when a router cannot be found.

Static IP

To use static IPv6 addresses the PDU must either have its "IPv6 Autoconfigure" setting disabled or "IPv6 fallback to static IP" enabled in the web interface. To change the static IPv6 addresses, fill in a valid IPv6 into fields "IP6 address 1" and/or "IP6 address 2"; see next chapter. These settings can be found under "interfaces → network configuration".

¹ https://en.wikipedia.org/wiki/IPv6_address

² <https://en.wikipedia.org/wiki/Hexadecimal>

How to configure IPv6?

Network Configuration

DHCP & Static IP Settings

Link Speed/Duplex Mode	Autonegotiate
DHCP	enabled
DHCP fallback to static IP	enabled, will fallback to static IP on failure
DHCP fallback delay (s)	10
IPv4 address	192.168.1.220
subnet mask	255.255.255.0
gateway address	192.168.1.1
primary DNS	0.0.0.0
secondary DNS	0.0.0.0
hostname	Schleifenbauer_SVNL001
IP protocol select	IPv4/IPv6 dual-stack
IPv6 address 1	::
IPv6 address 2	::
IPv6 Autoconfigure	enabled
IPv6 fallback to static IP	enabled



The IPv6 settings can be found in the PDUs web interface at the tab < Interfaces> block < Network Configuration >.

The PDU will always generate a Link-local address which starts with "FE80::".

This address is auto-generated and loses its scope at the first encountered network node.³

The IPv6 addresses can be found on the web interface or on the "IPv6 Link" page on the PDU display as shown in the image below.

To enable IPv6 support, the user must login to the PDU using the IPv4 address presented on the display. After login, select the tab "interfaces". In section network configuration is a drop-down box called "IP Protocol select". The default value of this drop-down box is "IPv4 only".

To enable IPv6 set this to either "IPv6 only" or "IPv4/IPv6 dual-stack", which means the PDU can communicate through both protocols.

Note that selecting "IPv4 only" or "IPv6 only" requires one of the filtering ranges to be all zero (allow all addresses). This is to prevent users from locking themselves out. Filtering ranges can be configured afterwards when the user has connected to the bridged and/or hybrid PDU using the protocol previously specified.

Enabling IPv6 adds an additional page to the PDU display named "IPv6 LINK" (see image). The current IP Mode is also visible if the user navigates to the "IP INTERFACES" display.

³ https://en.wikipedia.org/wiki/Link-local_address#IPv6

How to set up IPv6 address filtering?

IPv6 address filtering settings can be found at tab < Interfaces > block < Access control > from within the web interface. The web interface shown in the image below allows users to specify three IP ranges which grant access, anything outside of these IP ranges will be blocked. If the user wishes to configure only a single range, all three boxes should be filled with that range.



All "allowed IPv6 range" fields must be filled in order for the filter(s) to have effect !

Setting any address with prefix "0" will allow any address to access the PDU web interface, SNMP, modbus etc. Setting the address to ":::" (all zero's) and the prefix to a number between 0 and 128, will limit the allowed IP scope to the network the PDU is connected to. Filtering will then be disabled.

IPv6 example

Setting a filter of A76F::D222:12FF:FEB0:F48/64 will allow any address starting with A76F:0000:0000:0000: (A76F::) but other addresses such as A76A::32D4:731B:F17B:6 will be blocked. For a more detailed explanation see the Wikipedia page on IPv6 subnetting⁴. Please note that filtering requires a complete and valid IP address to function properly.

<table style="width: 100%; border-collapse: collapse;"> <tr> <td style="width: 20%;">allowed IPv6 range 1</td> <td style="width: 60%;"><input type="text" value="::"/></td> <td style="width: 20%;"><input type="text" value="/0"/></td> </tr> <tr> <td>allowed IPv6 range 2</td> <td><input type="text" value="::"/></td> <td><input type="text" value="/0"/></td> </tr> <tr> <td>allowed IPv6 range 3</td> <td><input type="text" value="::"/></td> <td><input type="text" value="/0"/></td> </tr> </table>	allowed IPv6 range 1	<input type="text" value="::"/>	<input type="text" value="/0"/>	allowed IPv6 range 2	<input type="text" value="::"/>	<input type="text" value="/0"/>	allowed IPv6 range 3	<input type="text" value="::"/>	<input type="text" value="/0"/>	<p><i>IPv6 filtering ranges</i></p>
allowed IPv6 range 1	<input type="text" value="::"/>	<input type="text" value="/0"/>								
allowed IPv6 range 2	<input type="text" value="::"/>	<input type="text" value="/0"/>								
allowed IPv6 range 3	<input type="text" value="::"/>	<input type="text" value="/0"/>								
<table style="width: 100%; border-collapse: collapse;"> <tr> <td style="width: 20%;">IPv6 link-local address</td> <td style="width: 80%;">FE80::D222:12FF:FEB0:F48</td> </tr> <tr> <td>IPv6 address 1</td> <td>AF::D222:12FF:FEB0:F48</td> </tr> <tr> <td>IPv6 address 2</td> <td>::</td> </tr> </table>	IPv6 link-local address	FE80::D222:12FF:FEB0:F48	IPv6 address 1	AF::D222:12FF:FEB0:F48	IPv6 address 2	::	<p><i>PDUs current IPv6 addresses.</i></p>			
IPv6 link-local address	FE80::D222:12FF:FEB0:F48									
IPv6 address 1	AF::D222:12FF:FEB0:F48									
IPv6 address 2	::									

⁴ https://en.wikipedia.org/wiki/IPv6_subnetting_reference

Configure SSL certificates

For increased security the communication can be encrypted using SSL certificates.

Key Generation

Certificates with a public and private key can be uploaded with the web interface. The certificates are used for the authentication phase of the handshake. These certificates can be generated in 3 steps:

1. Generate a private key
2. Generate a CSR (Certificate Signing Request) with the private key.
3. Create a self-signed certificate with the CSR.

The following private keys will be supported:

1. RSA (1024 bit)
2. Elliptic Curve (secp256r1/ prime256v1 and secp384r1)

TLS Cipher Suites Supported:

The TLS cipher suites are listed in the following format (example):

TLS_DHE_RSA_WITH_AES_256_GCM_SHA384

1. TLS prefix
2. Key Exchange algorithm (DHE) (Excluded for static keys)
3. Authentication algorithm (RSA)
4. Encryption algorithm (AES)
5. Encryption strength (256)
6. Encryption mode (GCM)
7. MAC (SHA284)

The certificate uploaded is used for the "Authentication algorithm" (RSA or Elliptic Curve). Other options (Key Exchange, Encryption etc) are selected from what the client lists as supported in the "Client Hello". The following cipher suites are supported:

Static Key with RSA:

- MBEDTLS_TLS_RSA_WITH_AES_128_GCM_SHA256
- MBEDTLS_TLS_RSA_WITH_AES_128_CBC_SHA256
- MBEDTLS_TLS_RSA_WITH_AES_256_CBC_SHA256
- MBEDTLS_TLS_RSA_WITH_AES_128_CBC_SHA
- MBEDTLS_TLS_RSA_WITH_AES_256_CBC_SHA

Ephemeral Elliptic-curve Diffie–Hellman with elliptic curve:

- MBEDTLS_TLS_ECDHE_ECDSA_WITH_AES_128_CBC_SHA
- MBEDTLS_TLS_ECDHE_ECDSA_WITH_AES_256_CBC_SHA
- MBEDTLS_TLS_ECDHE_ECDSA_WITH_AES_128_CBC_SHA256
- MBEDTLS_TLS_ECDHE_ECDSA_WITH_AES_128_GCM_SHA256

Elliptic-curve Diffie–Hellman with elliptic curve:

- MBEDTLS_TLS_ECDH_ECDSA_WITH_AES_128_CBC_SHA
- MBEDTLS_TLS_ECDH_ECDSA_WITH_AES_256_CBC_SHA
- MBEDTLS_TLS_ECDH_ECDSA_WITH_AES_128_CBC_SHA256
- MBEDTLS_TLS_ECDH_ECDSA_WITH_AES_128_GCM_SHA256

Note on self-signed certificates

At the moment only self-signed certificates are supported.

Certificate Generation

OpenSSL can be used to generate the private keys and certificates.

We can provide scripts for this purpose if requested.

Adding the certificates

1. Unlock “Webserver” block
2. Select or add HTTPS to the webserver section “HTTP/HTTPS”
3. Select the port (default: 443) you want to use for communication with HTTPS
4. Click “Save Changes”

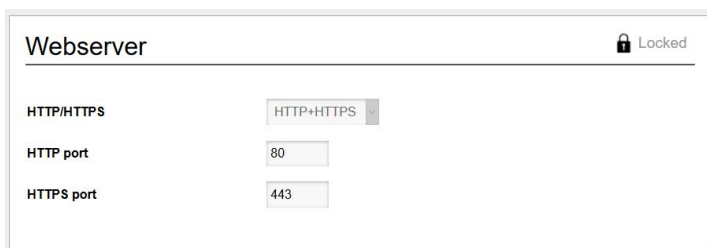

The screenshot shows a configuration window titled "Webserver" with a "Locked" status indicator. It contains three settings:

Setting	Value
HTTP/HTTPS	HTTP+HTTPS
HTTP port	80
HTTPS port	443

Procedure (continued):

5. Unlock "Certificates" block
6. Set "Use custom certificates" to enabled
7. Load your certificate into an editor, select the text and paste it in the appropriate box
8. Load your private key into an editor, select the text and paste it in the appropriate box
9. Click "Save Changes"
10. Go to the system tab and reboot the PDU to actualize your new configuration.

Certificates Editable

Save Changes

Settings will be effective after restart of CPU.

Certificate Common Name (CN) Schleifenbauer

Use custom certificates

Paste certificate below

-----BEGIN CERTIFICATE-----

Paste key below

-----BEGIN PRIVATE KEY-----

How to send SNMP Traps with IPv6?

The PDU allows the user to set two SNMP trap destinations. Traps occur when an alert has been triggered in the PDU. These destinations are located at "interfaces → SNMP" in the PDU web interface. The "trap destination address" fields can be set to IPv4 addresses if IPv4 is enabled and IPv6 addresses if IPv6 is enabled, or both when dual-stack is enabled at IP Protocol select.

trap destination address 1	<input type="text" value="AF::2"/>	<i>Using IPv6 traps</i>
trap destination address 2	<input type="text" value="AF::D256:B4A7"/>	

How to stop alert signaling? (auto reset alert)

From firmware 2.40 and newer it's possible to select a duration time after which the alert will be cleared after the cause of the alert is resolved. It's no longer necessary to clear the alert on the PDU or via an interface after the event which led to an alert is resolved.

Important: Alerts are always caused by issues that need to be resolved as soon as possible. So it is important that the alerts are recorded/logged in a management system.

FIRMWARE DOWNGRADE / UPGRADE

The development of the PDU firmware is an ongoing process. With every new release not only issues are fixed, but new features are also added. There will be miscellaneous minor improvements and fixes, but also general performance and stability improvements. Always make sure the firmware is up to date to ensure the PDUs are equipped with the latest technology and newest features.

If devices are connected in a databus ring, upgrading of all attached devices can be done remotely! During the upgrade process the power distribution won't be interrupted. Our firmware, firmware tools and manual can be downloaded from our website and can be used for free.

When a Schleifenbauer Gateway is present in the databus make sure the Gateway firmware is upgraded first. This firmware is listed on the documentation page of the Schleifenbauer website. The latest firmware, manual and updaters tool is listed on the support page of our website www.schleifenbauer.eu.

How to upgrade the firmware? Using SPST

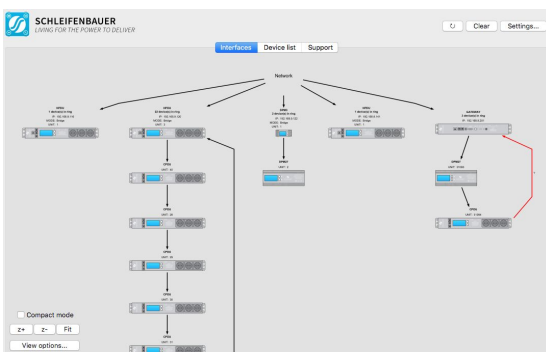

SPST is short for "Schleifenbauer Products Service Tool". This program aims to aid customers in analyzing and maintaining their network of Schleifenbauer PDUs and DPM-energy meters. SPST provides the following features:

- 🌀 Users can "quick scan" the status of the databus.
- 🌀 Users can up-/downgrade firmware easy and simple.
- 🌀 Users can remotely mass configure databus devices.
- 🌀 SPST will decrease problem solving lead time.

SPST and it's manual can be downloaded at www.schleifenbauer.eu. We advise our customers to read the manual before using SPST. One of the purposes of the SPST tool is to make firmware updating and mass configuration easier.

How to upgrade the firmware? Using USB

All G3 products are equipped with a USB port near the PDU display. USB support is enabled by default if it hasn't been explicitly disabled by the user. To start the update process make sure that USB support is enabled in the web interface. This can be done in the <system> -> settings section at the web interface. Alternatively, it is possible to enable or disable the USB interface with the Modbus or SNMP interface.

Download the latest firmware from <https://docs.schleifenbauer.eu/?dir=Firmware>.

The firmware is provided as a single ZIP-archive. Please extract the **entire contents** of this archive onto a **blank FAT32-Formatted USB stick**. Safely remove this USB stick from the PC and insert it into a PDU. The upgrade starts automatically.

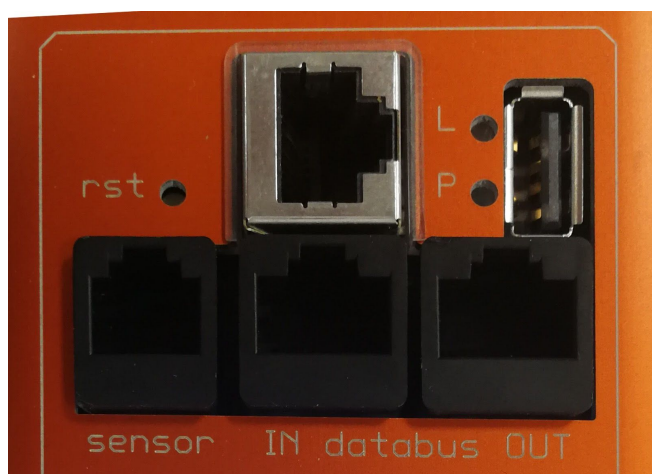

SCHLEIFENBAUER DATABUS: WHAT IS IT?

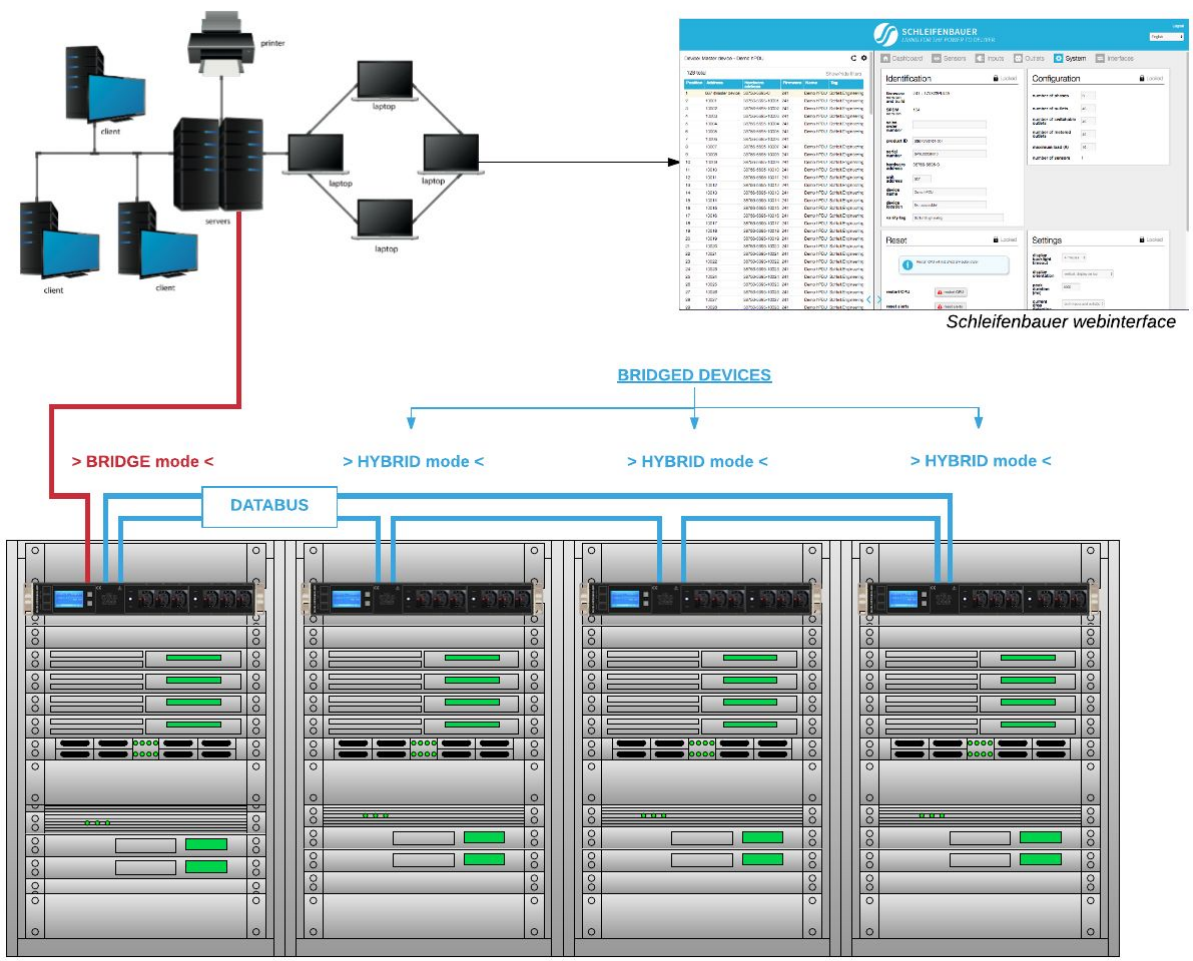

The intelligence of Schleifenbauer PDUs (and DPM energy meters) makes it possible to read and manage devices remotely over IP. It's possible for example to access the databus via the web interface, MODBUS and SNMP.

The databus provides a wide range of options: it has adequate support for custom configurations that are desired by the user.

Databus and power distribution are separated in the Schleifenbauer PDU. All operations on the databus do NOT interfere with the distribution of power to the connected equipment in the racks.

Advantages of the databus:

- easy to build: Pick a PDU and connect it to a local area network, daisy chain the rest of the PDUs and a databus is created.
- remote updating of the firmware.

Explanation of the image:

- the PDU/DPM-energy meter that is connected to the LAN must be in “**BRIDGE**” mode; this is the MASTER device.
- all “daisy chained” devices must be in “**HYBRID**” mode; these are the BRIDGED devices.

How to prevent data losses because of cable cuts? Ring redundancy

The advantage of ring redundancy per PDU is that a cable cut will not affect the other PDUs on the bus. This could happen in a normal daisy chained serial bus topology.

However, Schleifenbauer has made their bus redundant. A single cable cut will not affect the readout or control of the PDUs; it will try to get access through the alternative route on the ring. A cable cut is detected by our firmware and an error message will be submitted to the database. This error becomes visible in the “ring” icon (that is open or closed), which can be found on the right side of the “Device list”. The disadvantage of a serial bus topology is therefore covered in the Schleifenbauer system.



See Part I “How to connect a databus” on the PDU

How to create a databus using Schleifenbauer Gateway?

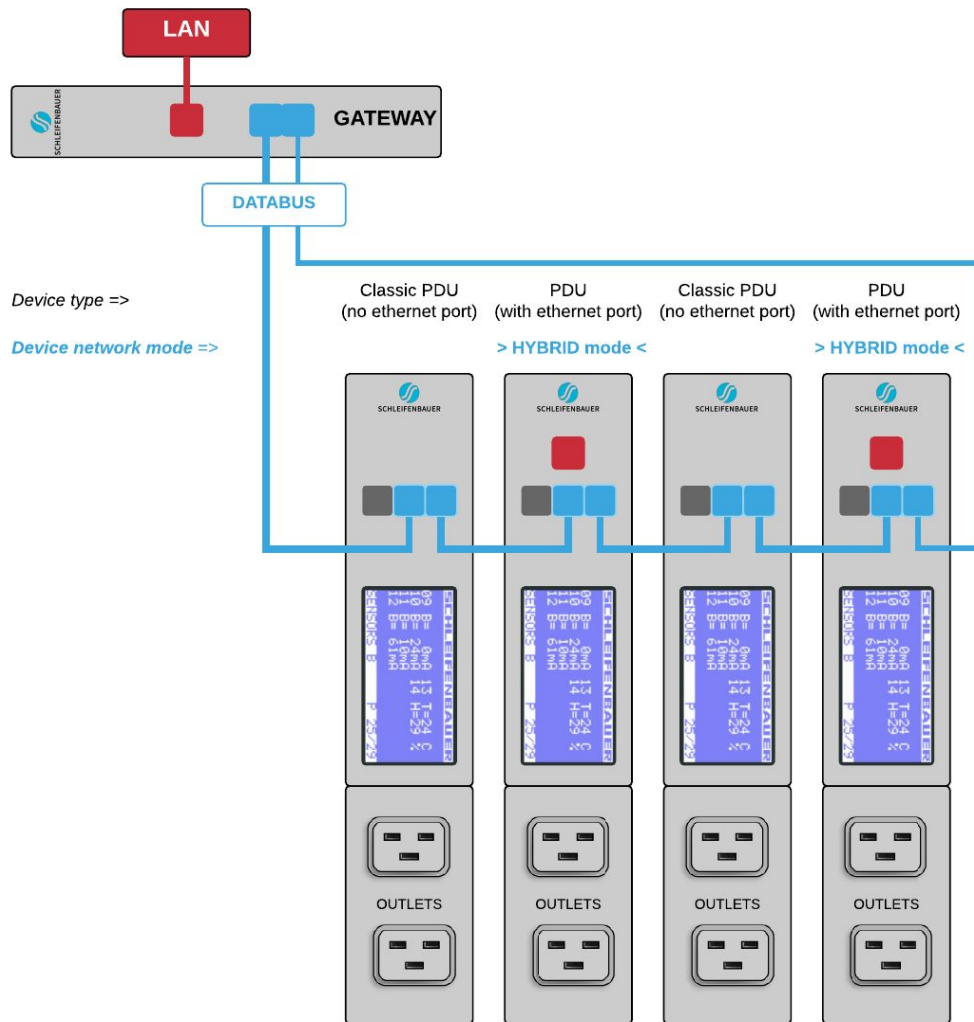

In the image above a small databus-ring with four PDUs connected to the Schleifenbauer Gateway can be seen. The Classic PDU has NO ethernet port, so a (Schleifenbauer) Gateway is needed in order to get PDUs connected to your LAN. The sequence of devices does not affect the performance of the Gateway or the databus. More devices in the databus equals more communication. This does result in a slightly slower data transmission. Our advise is to always close the databus-ring. To do so, connect the last device in the databus to the Gateway (blue lines in the image). In a closed databus ring the Gateway is able to reach all connected devices through IN and OUT databus-ports (clockwise and counter-clockwise).

Advantage: one IP-address makes it possible to collect data from a number of connected Schleifenbauer-devices (not only PDUs but also the Schleifenbauer DPM-range (=energy meters).

Disadvantage: gateway uses 1U in terms of rack-space.

Problem solving: if the Gateway fails, it's possible to change to the next configuration: using the “bridge” mode.



Databus communication takes 0,2 seconds per query (e.g. input measures block). Therefore we advise to create rings with a maximum of 50 devices which means that querying each device once will take approximately ten seconds.

How to connect the databus to LAN without a Gateway? Using a PDU!

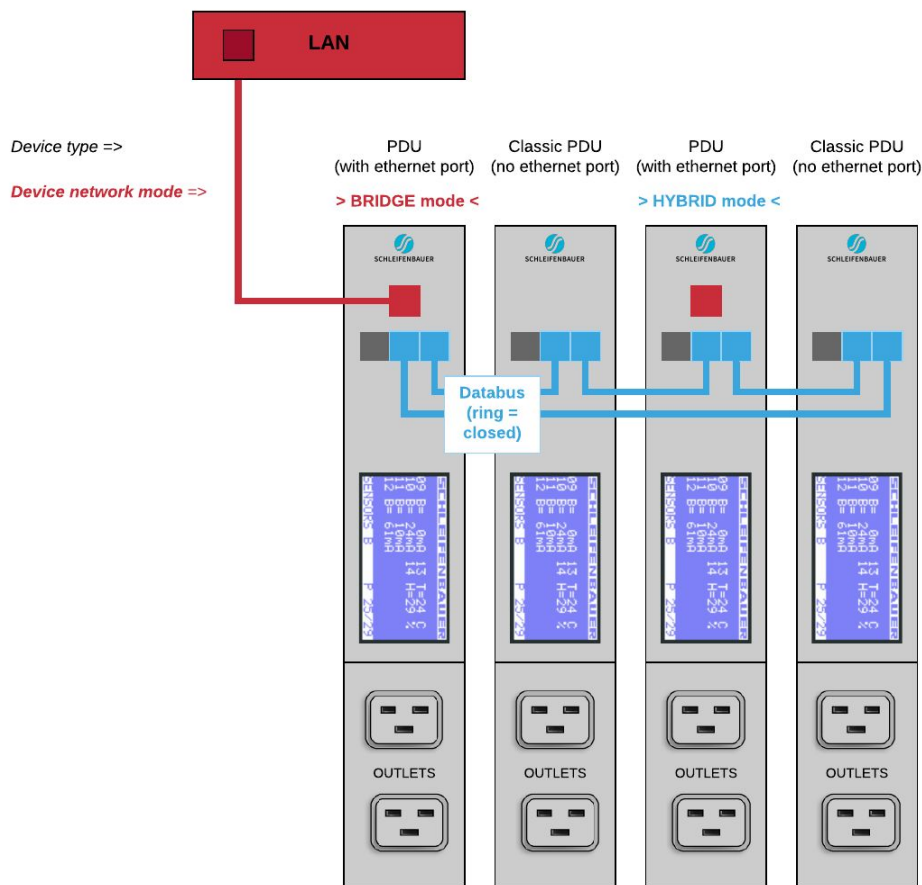

The image above shows a small databus-ring with only four devices connected to a LAN: a Classic PDU and PDU with ethernet port. The device connected to the LAN must have an ethernet port and be in "BRIDGE" mode. All other devices should be in "Hybrid" mode. The BRIDGED device takes over the function of the Schleifenbauer Gateway.

It's possible to connect numerous Schleifenbauer devices to the device which is in BRIDGE mode: PDUs and DPM3's (= three channel energy meter) as well as Classic PDUs and DPM27 (= 27 channel energy meter). The sequence of devices does not affect the performance of the databus-ring. But, the more devices you place in the databus-ring, the slower data transmission will be. The image shows that different Schleifenbauer devices can be connected in a ring which makes the system easily scalable to customer needs. It is advised to close the databus ring. Connect the last device in the databus to the device in BRIDGE-mode. In a

closed databus ring all connected devices are reachable through IN and OUT databus ports (clockwise and counter-clockwise).

Advantages: (1) when only using devices with ethernet port: only the device in BRIDGE mode uses one IP-address. (2) it's possible to select any device connected to the local area network as long as it is in BRIDGE mode, (3) investment in a Schleifenbauer Gateway is not necessary, (4) the system is easily scalable.

Disadvantage: MySQL and SMTP can not be used.



Databus communication takes 0,2 seconds per query (e.g. input measures block). Therefore we advise to create rings with a maximum of 50 devices which means that querying each device once will take approximately ten seconds.

PART IV - PROBLEM SOLVING

How to perform a “Software reset”? And why?

When Interface-settings are changed the CPU has to be restarted in order to adapt to the new settings. In the web interface a pop up will appear when a restart is required:

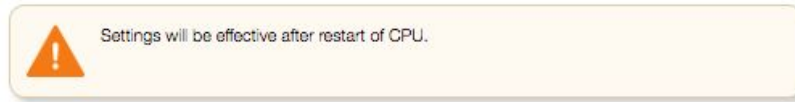

Remotely

A software reset can be performed in the web interface. It is important to understand that a software reset has no impact on power distribution of the PDU. So a reset can be performed at any time without having to interrupt the power supply and without losing the settings in the PDU.

Locally

TA PDU can be restarted using a paperclip or a similar sized object to press the reset button. This button is mounted behind the hole labelled as 'rst' on the PDU next to the Ethernet connection port.

How to perform a “Factory reset”?

If the PDU can no longer be accessed through the local area network, for example, because settings have been changed, restoring IP access may be required. The following procedure causes the PDU to adopt various default values, which allows it to be redetected on the network without losing any of the other settings in the PDU. However, the power supply must be interrupted in order to perform this restore procedure! The procedure is described in five steps:

1. Interrupt the power supply to the PDU.
2. Restore the power supply.
3. Wait for one second and afterwards press the reset button using a paper clip.
4. Wait for another second and press the reset button again.
5. Wait for another second and press the reset button again.

The PDU has now adopted the default values for the IP settings. The access control fields and the web server settings have also been returned to the standard values.

Please note that because the power is removed, outlets will also be out of power. Hence, during this process there won't be any measuring.

Please keep in mind that kWh totals will **NOT** be reset during this process.

How to reset peak current? And other dips or peaks

Example: The “overcurrent alert at” is set on 5.00A in the <input > tab. At a certain moment in time an alert in the web interface dashboard appears. Check the Inputs-tab and notice the peak current of 8.30A in this example image:

peak current	voltage	min voltage	overcurrent alert at
8.30	228.93	222.26	5.00

Clear the alert locally or by the reset button in the <Reset> section in the System-tab, the peak current will not be cleared. This is done manually by clicking the <reset peaks and dips> button in the <Reset> section of the System-tab:

reset peaks and dips



RECYCLING

Schleifenbauer Products aims to be a socially responsible corporation. Therefore, it makes great effort to minimise the impact of our products to our planet during production as well as during operation. Packaging consists of recyclable materials and Schleifenbauer asks their customers to save them for future use or to dispose of them with applicable regulations.

PRODUCT SPECIFICATIONS

	OPERATING
Temperature	0° to 60° Celsius
Height	-30 to +2000 m
Relative humidity	10 to 90% non-condensing
Level of pollution	2
Environment	Indoors IP20
Class of equipment	Class I
Protective rating	II
Conditions of use	Continuous

Voltage: single-phase 100-230 VAC; three-phase 230/400 VAC
Frequency: 50/60 Hz
Permitted load: see product information on your PDU
Accuracy: EN 50470-1/3 class B, EN 62053-21: class 1, ± 1%
Wire colour code: L1 = BROWN
L2 = BLACK
L3 = GREY
N (neutral) = BLUE
PE = YELLOW/GREEN

SERVICE AND SUPPORT

Please contact us in case there are questions regarding our products:

T: +31 73 5230256
F: +31 73 5212383
E-mail: support@schleifenbauer.eu
Website: <http://schleifenbauer.eu/>

If an email is sent, a case is created automatically with a unique case number. The request will be investigated in detail and proper actions will be taken. Correspondence about the case will be done with the unique number as reference.

© Schleifenbauer is a registered trademark.
This publication is protected by copyright.
No part of it may be reproduced or transmitted in any form,
without prior consent in writing from Schleifenbauer Products BV.